

Providing sustainable energy solutions worldwide

Installation and Maintenance Manual
CTC EcoPart Pro/Basic

Model i425-i435 / 425-435

Important!

- Read carefully before use, keep for future reference.
- Translation of the original instructions.



Removing the cooling module

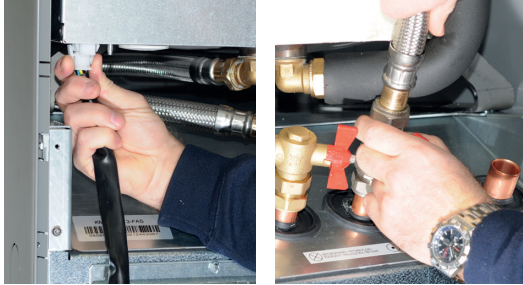

1. Disconnect the cooling module's power cable connector and hoses.



2. Attach the two carrying handles to the bottom of the cooling module.



3. Unscrew the cooling module's screws.



4. Pull the cooling module by first lifting the front edge slightly with the carrying handles.



5. Lift the cooling module using the carrying handles and shoulder straps.

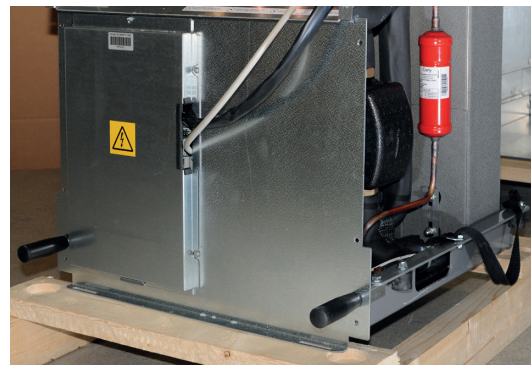

6. Lift the cooling module into the product using the carrying handles and shoulder straps. Remove the carrying handles and reconnect the power cable, hoses and screws.

Installation and Maintenance Manual

CTC EcoPart Pro/Basic

Model i425-i435 / 425-435

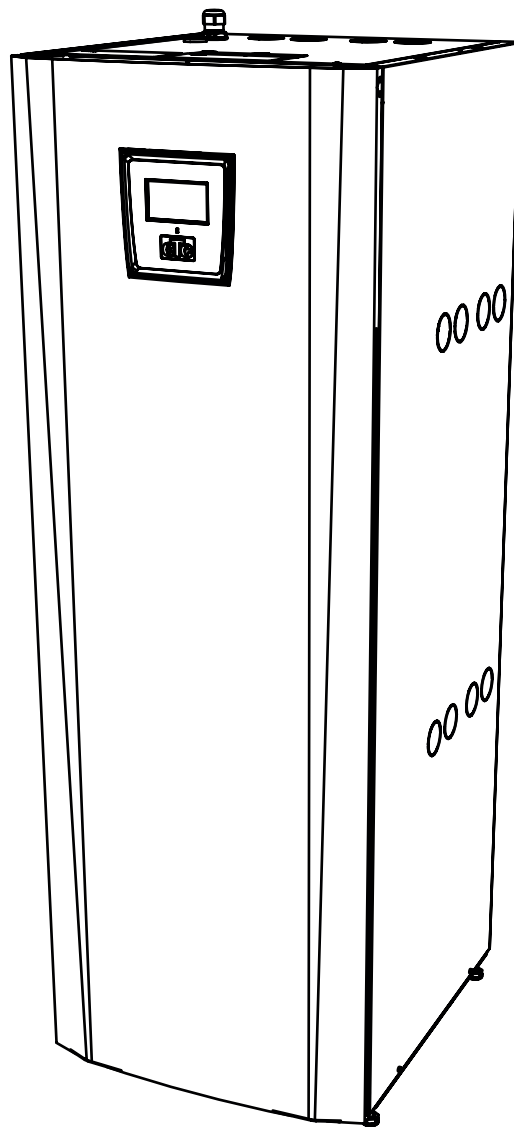

Table of Contents

Important to remember!	6	6.	First start	52
Checklist	7	7.	Operation and Maintenance	52
Safety instructions	8	7.1	Periodic maintenance	52
1. Introduction	9	7.2	Operation stop	52
2. Technical data	10	7.3	Service position	52
2.1 Table 400 V 3N~	10	8.	Troubleshooting/Appropriate measures	53
2.2 Table 230 V 1N~	12	8.1	Air problems	53
2.3 Component location	13			
2.4 Dimensions diagram	14			
2.5 Refrigerant system	15			
2.6 Operating range	15			
3. Installation	16			
3.1 Delivery includes:	17			
3.1.1 Non-return valve 1 ¼"	17			
3.2 Connection	18			
3.3 Heat medium side	19			
3.4 Circulation pumps, heat medium side	20			
3.4.1 Yonos Para pump curve	20			
3.4.2 UPMGEO pump curve	20			
3.5 Brine system	21			
3.6 Brine pump	25			
4. Electrical installation	26			
4.1 Alarm output	26			
4.2 Groundwater heating	26			
5. Connecting the control system	27			
5.1 CTC EcoPart i425-i435 Pro	27			
5.2 CTC EcoPart 425-435	28			
5.3 Series connection of heat pumps	29			
5.3.1 Terminated position	29			
5.3.2 Shielded communication	30			
5.3.3 Example of series connection	31			
5.4 Connecting the control system	32			
5.4.1 Define number of heat pumps	32			
5.4.2 Numbering CTC EcoPart as HP2	32			
5.4.3 Worth knowing when addressing	34			
5.4.4 Numbering CTC EcoPart as A2	35			
5.5 Wiring diagram for CTC i425-i435 Pro 400V 3N~	38			
5.6 Electrical diagram, lower cooling module 400V 3N~ L2	40			
5.7 Electrical diagram, upper cooling module 400V 3N~ L3	42			
5.8 Electrical diagram CTC EcoPart i425-i430 Pro 230V 1N~	44			
5.9 Power supply and communication 230V 1N~	46			
5.10 Power supply and communication 400V 3N~	47			
5.11 Electrical diagram cooling module 230V 1N~	48			
5.12 Resistances for sensors	49			
5.13 Parts list	51			

Congratulations on buying your new product!



The complete heat pump for rock, ground or lake

The CTC EcoPart i425-i435 is a heat pump which takes heat from rock, ground or lake and supplies it to the existing heating circuit in the house.

The heat pump is intended for commercial use and can be connected to the property's heating and DHW system according to the system example in CTC EcoLogic L.

CTC EcoPart has been designed to operate with high efficiency and low noise levels.



This manual does not describe the controls for CTC EcoLogic L or CTC Basic Display; we refer you instead to the relevant manuals for these products.

Important to remember!

Check the following points in particular at the time of delivery and installation:

- The product must be transported and stored in an upright position.
- Remove the packaging and check before installation that the product has not been damaged in transit. Report any transport damage to the carrier.
- Place the product on a solid foundation, preferably made of concrete. If the product needs to be placed on a soft carpet, base plates must be placed under the adjustable feet.
- Remember to leave a service area of at least 1 metre in front of the product.
- The product must not be placed below floor level either.
- Avoid placing the product in rooms where the walls are of lightweight design, as people in the adjoining room may be disturbed by noise and vibrations.
- Ensure that pipes used between the heat pump and the heating circuit are of adequate dimensions.
- Register the product for warranty and insurance via the website <https://ctc.se/kundservice#garantiregistrering>
<https://www.ctc-heating.com/customer-service#warranty-registration>



Information in this type of box [i] is intended to help ensure that the product functions optimally.



Information in this type of box [!] is particularly important for correctly installing and using the product.

When contacting CTC, always mention the following:

- Serial number
- Model/Size
- the fault message shown in the display
- Your telephone number

CTC EcoPart 425-435

The 12-digit serial number is found on a sticker affixed to the top cover of the product.

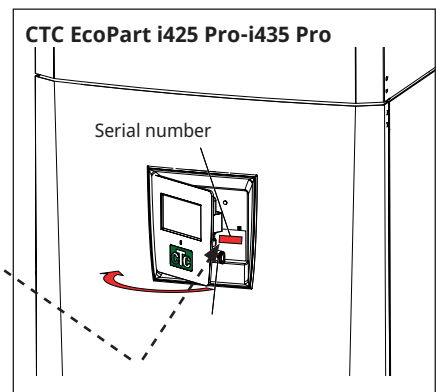

For your own reference

Fill in the information below. It may come in useful if anything should happen.

Product:	Serial number:
Installer:	Name:
Date:	Tel. no.:
Electrical installer:	Name:
Date:	Tel. no.:

No liability is accepted for any misprints. We reserve the right to make design changes.

Checklist

The checklist must always be completed by the installation engineer

- If a service is performed, you may be required to provide this document.
- Installation must always be done according to the installation and maintenance instructions.
- Installation must always be carried out in a professional manner.

Following installation, the unit must be inspected and functional checks performed as indicated below:

Pipe installation

- Heat pump filled, positioned and adjusted in the correct manner according to the instructions.
- The heat pump is positioned so that it can be serviced.
- Capacity of the charge/radiator pump (depending on type of system) for the flow required.
- Open radiator valves (depending on type of system) and other relevant valves.
- Tightness test.
- Bleed the system.
- Check proper operation of the requisite safety valves.
- Requisite waste pipes connected to the floor drain (depending on type of system).

Electrical installation

- Safety switch.
- Correct and taut wiring.
- Requisite sensors fitted.
- Accessories.

Customer information (adapted to the relevant installation)

- Start-up with customer/installer.
- Menus/controls for selected system.
- Installation and Maintenance Manual handed over to the customer.
- Check and filling, heating circuit.
- Information on fine adjustments.
- Alarm information.
- Functional test of safety valves fitted.
- Register your Installation Certificate at ctc-heating.com.
- Information on fault reporting procedures.

Date/Customer

Date/Installer

Safety instructions



Turn off the power with an omnipolar switch before doing any work on the product.



The product must be connected to protective earth.



The product is classified as IPX1. The product must not be rinsed with water.



When handling the product with a hoist ring or similar device, make sure that the lifting equipment, eyebolts and other parts are not damaged. Never stand under the hoisted product.



Never jeopardise safety by removing bolted covers, hoods or similar.



Any work on the product's cooling system should be carried out by authorised personnel only.



The product's electrical systems should only be installed and serviced by a qualified electrician.

-If the supply cord is damaged, it must be replaced by the manufacturer, its service agent or similarly qualified persons in order to avoid a hazard.



Safety valve check:

-Safety valve for boiler/system to be checked regularly.



The product must not be started if it is not filled with water; instructions are in the "Pipe installation" section.



This device can be used by children from the age of eight years and above and by people with reduced physical, sensory or mental ability or lack of experience or knowledge if they have been taught, either with supervision or with the instructions provided, how to use the device safely and understand the risks involved. Children should not play with the device. Cleaning and maintenance should not be carried out by children without supervision.



If these instructions are not followed when installing, operating and maintaining the system, Enertech's commitment under the applicable warranty terms is not binding.

1. Introduction

This heat pump is available in many different versions depending on how you intend to control it.

- The CTC EcoPart i425-i435 Pro has an integrated CTC EcoLogic M/L unit that controls the heat pumps and the property's heating circuit.
- The CTC EcoPart 425-435 has two CTC Basic Display units as standard.

The heat pump consists of two heat pump modules on top of each other. The structure of the different sizes is shown below.

3 x 400V 3N~

CTC EcoPart 425 &
CTC EcoPart i425 Pro

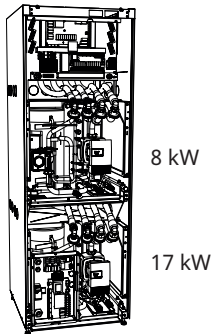

CTC EcoPart 430 &
CTC EcoPart i430 Pro

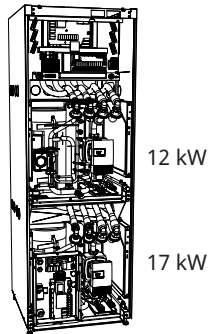

CTC EcoPart 435 &
CTC EcoPart i435 Pro

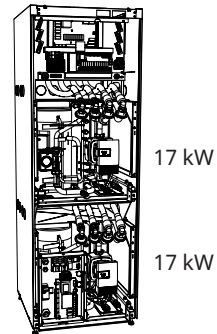

1 x 230V 1N~

CTC EcoPart 425 &
CTC EcoPart i425 Pro

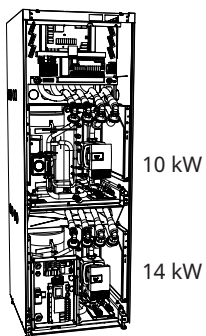

CTC EcoPart 430 &
CTC EcoPart i430 Pro

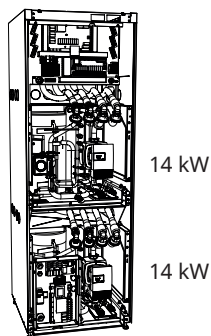

2. Technical data

2.1 Table 400 V 3N~

Electrical data		400V 3N~			
Name		CTC EcoPart i425 Pro		CTC EcoPart i430 Pro	
Type		KM417EP 2xLEP	KM408EP 2xLEP	KM417EP 2xLEP	KM412EP 2xLEP
Operating system		CTC EcoLogic Pro		CTC EcoLogic Pro	
Rated power	kW	15.4		17.0	
Rated current	A	22.2		24.6	
IP class		IPX1		IPX1	
Max. operating current Compressors	A	16.7		19.7	
Max. operating current Compressor	A	11.5	5.2	11.5	8.2

Electrical data		400V 3N~			
Name		CTC EcoPart 425		CTC EcoPart 430	
Type		KM417EP 2xLEP	KM408EP 2xLEP	KM417EP 2xLEP	KM412EP 2xLEP
Operating system		CTC Basic display		CTC Basic display	
Rated power	kW	10.8		12.4	
Rated current	A	21,1		23,5	
Protection class	IP	IPX1		IPX1	
Max. operating current Compressors	A	16.7		19.7	
Max. operating current Compressor	A	11.5	5.2	11.5	8.2
Max starting current	A	32.0	17.7	32.0	23.5

Operational data for heat pump		400V 3N~			
Output from compressor ¹⁾ @ -5/45	kW	20.89		23.93	
Output from compressor ¹⁾ @ -5/45	kW	14.05	6.84	14.05	9.88
COP ¹⁾ @ -5/45		3.19	3.34	3.19	3.30
Output from compressor ¹⁾ @ 0/35 0/45 0/55	kW	16.24 16.14 15.87	8.19 7.87 7.55	16.24 16.14 15.87	11.75 11.24 10.97
COP ¹⁾ @ 0/35 0/45 0/55		4.36 3.61 3.07	4.58 3.64 2.99	4.36 3.61 3.07	4.60 3.66 2.96
Output from compressor ¹⁾ @ 5/35 5/45 5/55	kW	19.25 18.42 18.16	9.44 9.05 8.65	19.25 18.42 18.16	13.53 12.95 12.57
COP ¹⁾ @ 5/35 5/45 5/55		5.02 4.05 3.38	5.02 4.04 3.30	5.02 4.05 3.38	5.11 4.11 3.35

¹⁾ EN14511:2007, inclusive circulation pumps

Heating system		400V 3N~			
Max temperature heating medium (TS)	°C	110			
Max. operating pressure water (PS)	bar	6.0			
Heating system min flow ²⁾	l/s	0.40	0.20	0.40	0.28
Kvs value $\Delta t = 10$ K, at min flow		5.9 (6 kPa)	4.1 (3 kPa)	5.9 (6 kPa)	5.5 (3.5 kPa)
Heating system nominal flow ³⁾	l/s	0.81	0.39	0.81	0.56
Heating medium pump		LEP (Low Energy Pump)			

²⁾ $\Delta t = 10$ K och 0/35 °C heat pump operation.

³⁾ $\Delta t = 5$ K och 0/35 °C heat pump operation.

Brine system		400V 3N~			
Water volume (V)	l	4.07	2.90	4.07	3.40
Brine system min/max temp. (TS)	°C	-5 / 20			
Brine system max pressure (PS)	bar	3.0		3.0	
Brine system min flow $\Delta t = 5$ K	l/s	0.63	0.31	0.63	0.44
Brine system nominal flow $\Delta t = 3$ K	l/s	1.05	0.51	1.05	0.73
Kvs value $\Delta t = 3$ K at nominal flow		8.9	5.8	8.9	7.2
Brine system pump		Class A circulation pump (LEP)			
Pump capacity		See diagram in the Pipe installation chapter			

Other data		400V 3N~			
Refrigerant quantity (R407C, fluorinated greenhouse gases GWP 1774)	kg	2.7	1.9	2.7	2.3
CO ₂ equivalent	ton	4.790	3.371	4.790	4.080
Compressor oil		Polyolester (POE)			
Pressure switch cut-off HT	MPa	3.1 (31 bar)			
Sound power L _{WA} (EN 12102)	dB(A)	45,6		45,4	
Weight net	kg	334		354	
Width x Depth x Height	mm	596 x 680 x 1760			
Heat pump Keymark Cert. NO.		012-068		012-071	

No annual leakage control of the refrigerant is required

Electrical data		400V 3N~	
Name		CTC EcoPart i435 Pro	
Type		KM417EP 2xLEP	KM417EP 2xLEP
Operating system		CTC EcoLogic Pro	
Rated power	kW	19,4	
Rated current	A	28,9	
IP class		IPX1	
Max. operating current Compressors	A	23.0	
Max. operating current Compressor	A	11.5	11.5

Electrical data		400V 3N~	
Name		CTC EcoPart 435	
Type		KM417EP 2xLEP	KM417EP 2xLEP
Operating system		CTC Basic display	
Rated power	kW	14.8	
Rated current	A	27,8	
Protection class	IP	IPX1	
Max. operating current Compressors	A	23.0	
Max. operating current Compressor	A	11.5	11.5
Max starting current	A	32.0	32.0

Operational data for heat pump		400V 3N~	
Output from compressor ¹⁾ @ -5/45	kW	14.05	14.05
COP ¹⁾ @ -5/45		3.19	3.19
Output from compressor ¹⁾ @ 0/35 0/45 0/55	kW	16.24 16.14 15.87	16.24 16.14 15.87
COP ¹⁾ @ 0/35 0/45 0/55		4.36 3.61 3.07	4.36 3.61 3.07
Output from compressor ¹⁾ @ 5/35 5/45 5/55	kW	19.25 18.42 18.16	19.25 18.42 18.16
COP ¹⁾ @ 5/35 5/45 5/55		5.02 4.05 3.38	5.02 4.05 3.38

¹⁾ EN14511:2007, inclusive circulation pumps

Heating system		400V 3N~	
Max temperature heating medium (TS)	°C	110	
Max. operating pressure water (PS)	bar	6.0	
Heating system min flow ²⁾	l/s	0.40	0.40
Kvs value $\Delta t = 10$ K, at min flow		5.9 (6 kPa)	5.9 (6 kPa)
Heating system nominal flow ³⁾	l/s	0.81	0.81
Heating medium pump		LEP (Low Energy Pump)	

²⁾ $\Delta t = 10$ K och 0/35 °C heat pump operation.

³⁾ $\Delta t = 5$ K och 0/35 °C heat pump operation.

Brine system		400V 3N~	
Water volume (V)	l	4.07	4.07
Brine system min/max temp. (TS)	°C	-5 / 20	
Brine system max pressure (PS)	bar	3.0	
Brine system min flow $\Delta t = 5$ K	l/s	0.63	0.63
Brine system nominal flow $\Delta t = 3$ K	l/s	1.05	1.05
Kvs value $\Delta t = 3$ K at nominal flow		8.9	8.9
Brine system pump		Class A circulation pump (LEP)	
Pump capacity		See diagram in the Pipe installation chapter	

Other data		400V 3N~	
Refrigerant quantity (R407C, fluorinated greenhouse gases GWP 1774)	kg	2,7	2,7
CO ₂ equivalent	ton	4.790	4.790
Compressor oil		Polyolester (POE)	
Pressure switch cut-off HT	MPa	3.1 (31 bar)	
Sound power L _{WA} (EN 12102)	dB(A)	45.6	
Weight net	kg	359	
Width x Depth x Height	mm	596 x 680 x 1760	
Heat pump Keymark Cert. NO.		012-072	

No annual leakage control of the refrigerant is required

2.2 Table 230 V 1N~

Electrical data		230V 1N~			
Name		CTC EcoPart i425 Pro		CTC EcoPart i430 Pro	
Type		KM414EP 2xLEP	KM410EP 2xLEP	KM14EP 2xLEP	KM414EP 2xLEP
Operating system		CTC EcoLogic Pro		CTC EcoLogic Pro	
Rated power	kW	15.3		17.2	
Rated current	A	33.5		38.0	
IP class		IPX1		IPX1	
Max. operating current Compressors	A	47.7		54.2	
Max. operating current Compressor	A	27.1	20.6	27.1	27.1
Name		CTC EcoPart 425		CTC EcoPart 430	
Type		KM414EP 2xLEP	KM410EP 2xLEP	KM414EP 2xLEP	KM414EP 2xLEP
Operating system		CTC Basic display		CTC Basic display	
Rated power	kW	10.7		12.6	
Rated current	A	24.0		28.0	
Protection class	IP	IPX1		IPX1	
Max. operating current Compressors	A	47.7		54.2	
Max. operating current Compressor	A	27.1	20.6	27.1	27.1
Max starting current	A	30.0	30.0	30.0	30.0
Operational data for heat pump		230V 1N~			
Output from compressor ¹⁾ @ -5/45	kW	12.09	8.33	12.09	12.09
COP ¹⁾ @ -5/45		3.24	3.30	3.24	3.24
Output from compressor ¹⁾ @ 0/35 0/45 0/55	kW	14.47 13.93 13.40	9.97 9.55 9.28	14.47 13.93 13.40	14.47 13.93 13.40
COP ¹⁾ @ 0/35 0/45 0/55		4.54 3.64 2.95	4.60 3.68 2.98	4.54 3.64 2.95	4.54 3.64 2.95
Output from compressor ¹⁾ @ 5/35 5/45 5/55	kW	16.48 15.98 15.28	11.42 10.99 10.58	16.48 15.98 15.28	16.48 15.98 15.28
COP ¹⁾ @ 5/35 5/45 5/55		5.13 4.11 3.28	5.20 4.16 3.28	5.13 4.11 3.28	5.13 4.11 3.28
¹⁾ EN14511:2007, inclusive circulation pumps					
Heating system		230V 1N~			
Max temperature heating medium (TS)	°C	110			
Max. operating pressure water (PS)	bar	6.0			
Heating system min flow ²⁾	l/s	0.34	0.24	0.34	0.34
Kvs value $\Delta t = 10$ K, at min flow		8.6	4.3	8.6	8.6
Heating system nominal flow ³⁾	l/s	0.68	0.48	0.68	0.68
Heating medium pump		LEP (Low Energy Pump)			
²⁾ $\Delta t = 10$ K och 0/35 °C heat pump operation.					
³⁾ $\Delta t = 5$ K och 0/35 °C heat pump operation.					
Brine system		230V 1N~			
Water volume (V)	l	4.07	2.90	4.07	4.07
Brine system min/max temp. (TS)	°C	-5 / 20			
Brine system max pressure (PS)	bar	3.0		3.0	
Brine system min flow $\Delta t = 5$ K	l/s	0.53	0.38	0.53	0.53
Brine system nominal flow $\Delta t = 3$ K	l/s	0.88	0.64	0.88	0.88
Kvs value $\Delta t = 3$ K at nominal flow		8.7	8.1	8.7	8.7
Brine system pump		Class A circulation pump (LEP)			
Pump capacity		See diagram in the Pipe installation chapter			
Other data		230V 1N~			
Refrigerant quantity (R407C, fluorinated greenhouse gases GWP 1774)	kg	2.7	1.9	2.7	2.7
CO ₂ equivalent		4.790	3.371	4.790	4.790
Compressor oil		Polyolester (POE)			
Pressure switch cut-off HT	MPa	3.1 (31 bar)			
Sound power L _{WA} (EN 12102)	dB(A)	45.6		45.4	
Weight net	kg	334		354	
Width x Depth x Height	mm	596 x 680 x 1760			
Heat pump Keymark Cert. NO.		012-068		012-071	

No annual leakage control of the refrigerant is required

2.3 Component location

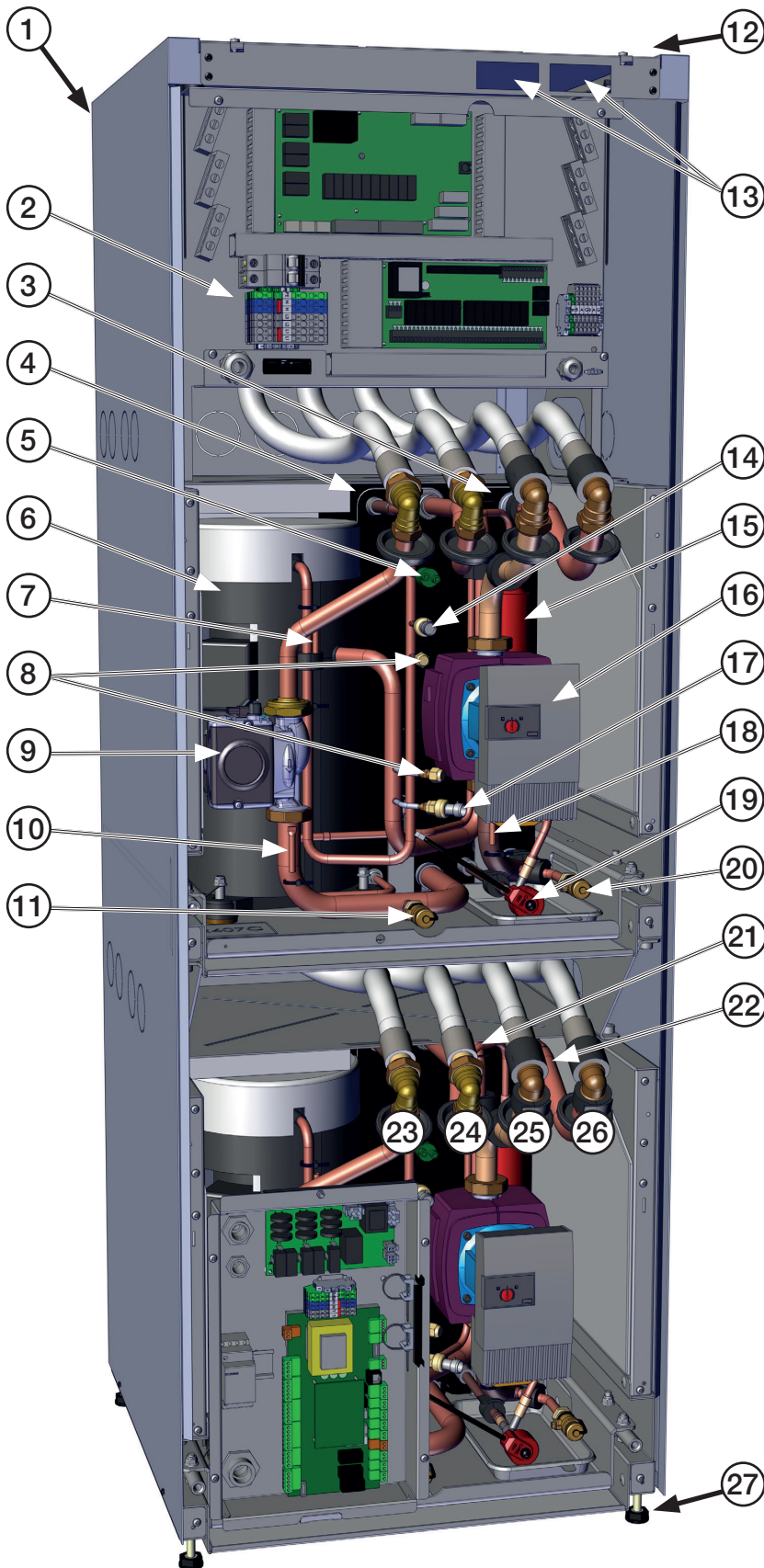

1. Conduit for mains cable (concealed)
2. Terminal board
3. Condenser
4. Evaporator
5. High pressure switch
6. Compressor
7. Discharge sensor
8. Service socket
9. Low energy heat medium pump
10. Condenser sensor in
11. Drain valve warm side/Water
12. Conduit for communication (concealed)
13. CTC Basic Display (only CTC EcoPart standard version)
14. High pressure sensor
15. Drying filter
16. Low energy brine pump
17. Low pressure sensor
18. Brine sensor out
19. Expansion valve
20. Drain valve cold side/Brine
21. Condenser sensor out
22. Brine sensor in
23. Heat medium in Ø28 (to HP)
24. Heat medium out Ø28 (from HP)
25. Brine out Ø28 mm (to rock)
26. Brine in Ø28 mm (from rock)
27. Adjustable feet

2.4 Dimensions diagram

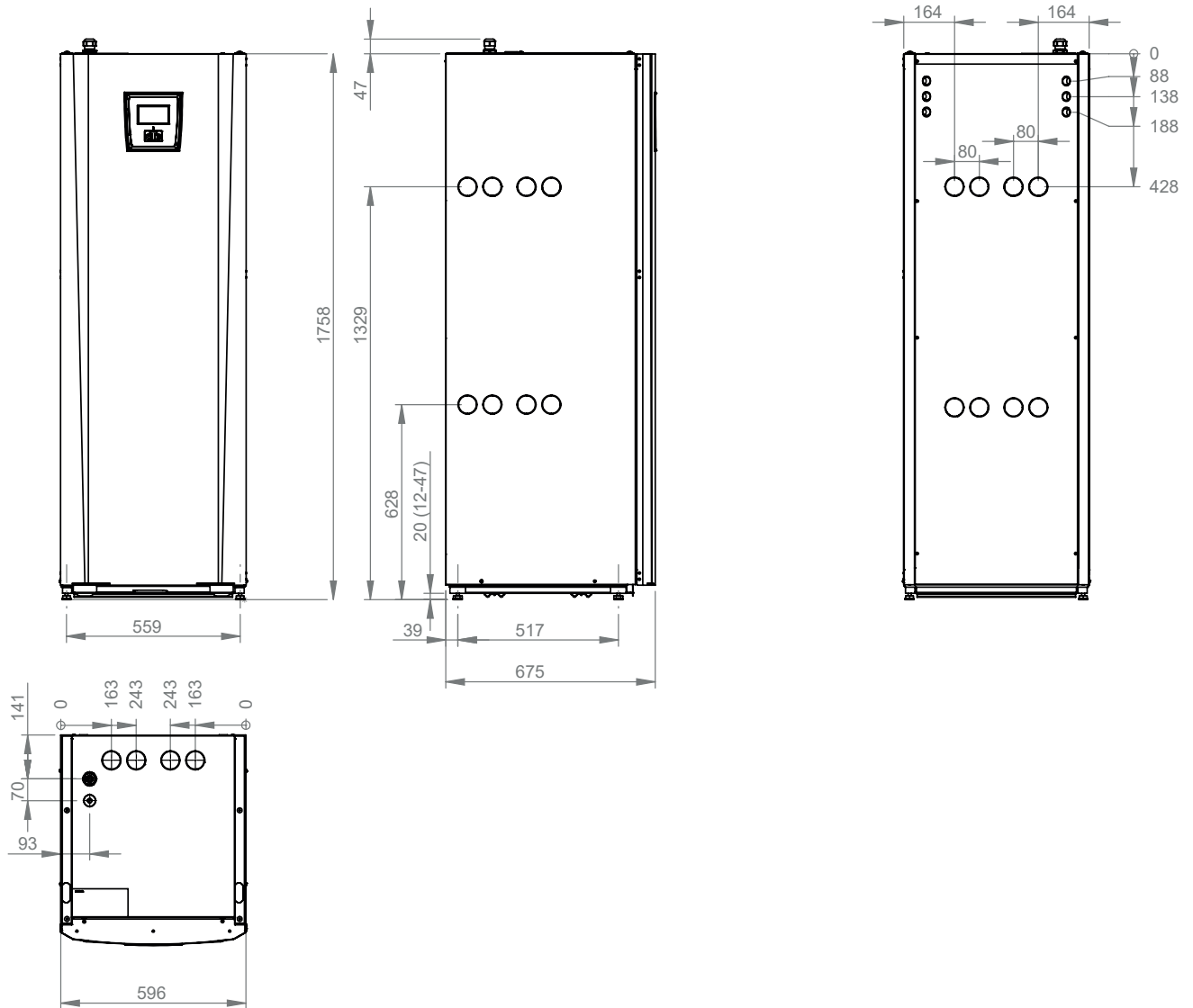

! Remember to leave a service area of at least 1 metre in front of the product.

2.5 Refrigerant system

The schematic diagram shows the refrigerant system for each integrated heat pump module.

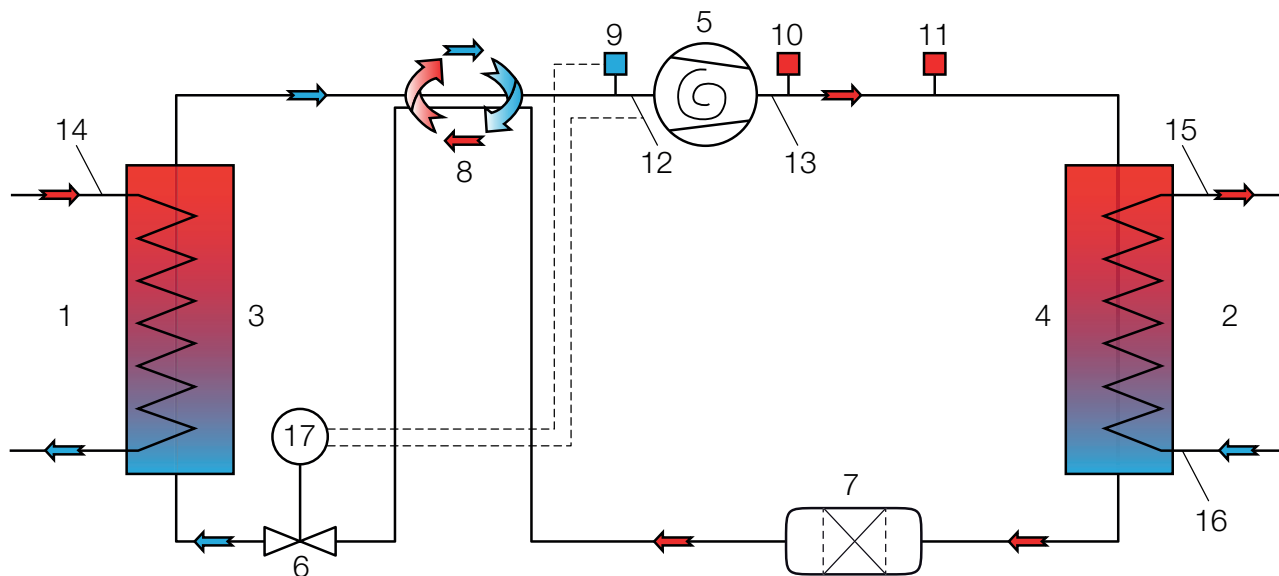

- | | | |
|---------------------------------|-------------------------------|-----------------------------|
| 1. Brine (heat source) | 7. Drying filter | 13. Temperature discharge |
| 2. Water | 8. Refrigerant heat exchanger | 14. Temperature brine |
| 3. Evaporator | 9. Low pressure sensor | 15. Temperature water out |
| 4. Condenser | 10. High pressure sensor | 16. Temperature water in |
| 5. Compressor | 11. High pressure switch | 17. Control expansion valve |
| 6. Expansion valve (electronic) | 12. Temperature suction gas | |

2.6 Operating range

CTC EcoPart's pressure-controlled operations monitoring means that the brine temperature (B) and heat medium temperature (H) can automatically be increased where this is possible.

Operating condition:	B temp/H temp °C
1	-5 / 25
2	20 / 25
3	-5 / 61
4	20 / 64

Operating limits as per the table above are defined in accordance with EN 14511-4.

3. Installation

This section is aimed at anyone responsible for one or more of the installations required to ensure that the product works the way the property owner wants.

Take your time going through functions and settings with the property owner and answer any questions. Both you and the heat pump benefit from a user who has completely understood how the system operates and should be maintained.

The installation must be carried out in accordance with current standards and regulations. Refer to MIS 3005 and associated building regulations Part L, F & G. The product must be connected to an expansion vessel in an open or closed system. Do not forget to flush the heating circuit clean before connection. Apply all the installation settings based on the description in the chapter on "First start".

The heat pump operates with a primary flow/return temperature across the condenser of up to 65/58°C.

Transportation

Transport the unit to the installation site before removing the packaging.

Handle the product in the following manner:

- Forklift
- Lifting band around the pallet. NB: Can only be used with the packaging on.

Unpacking

Unpack the heat pump when it is placed next to its installation site. Check that the product has not been damaged in transit. Report any transport damage to the carrier. Also check that the delivery is complete according to the list below.



The product must be transported and stored in an upright position.

3.1 Delivery includes:

Feed cables:

3x400 = 1 pcs

1x230 = 2 pcs

CTC EcoPart i425-i435 Pro (with CTC EcoLogic L):

- 1 x Safety valve ½" 3 bar
- 1 x Room sensor
- 3 x 22K sensor L=2,500 mm
- 1 x Outdoor sensor
- 4 x Non-return valve 1¼"
- 4 x Dirt filter 1¼"
- 4 x Rubber grommet D=60
- 4 x Edge moulding 186 mm
- 2 x Edge moulding 700 mm
- CTC EcoLogic M/L

CTC EcoPart 425-435 (with two CTC Basic Display units):

- 1 x Safety valve ½" 3 bar
- 4 x Non-return valve 1¼"
- 4 x Dirt filter 1¼"
- 4 x Rubber grommet D=60
- 4 x Edge moulding 186 mm
- 2 x Edge moulding 700 mm
- CTC Basic Display manual

3.1.1 Non-return valve 1 ¼"

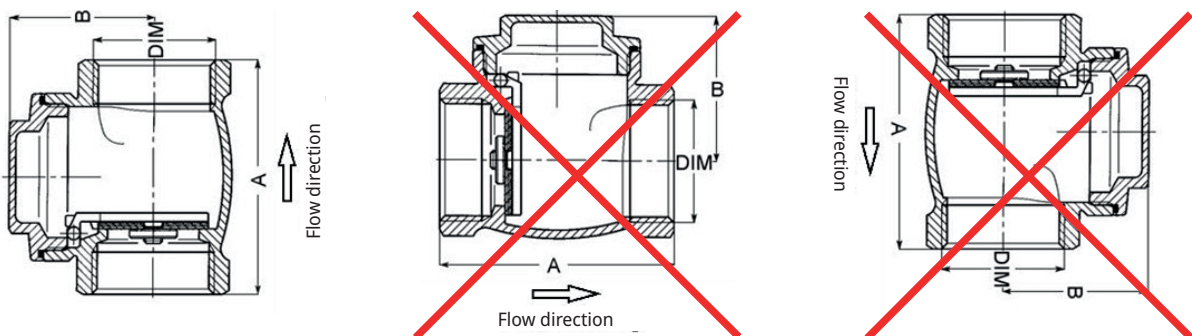

3.2 Connection

Connection can be made to the right, left or top or rear of the heat pump. Cut away the cover plate on the side where the hoses are to be connected. When the opening has been made through the cover plate, carry out the installation as follows:

1. In order to protect the hoses, Phaseten the protective edging provided around the edge of the opening in the insulation plate. Adjust the length of the protective edging to suit the opening as required.
2. Pass the hoses through the opening in the side cover plates and connect them. Ensure that the insulation covers all parts of the brine connection to prevent ice and condensation forming.
3. Then install the collector system.

You can also connect the primary flow on one side and the return on the other. See the section entitled "Measurement details for measurements and dimensions". The pipe between the heat pump and brine loop should not be less than $\varnothing 35$ mm in dimension.

 When a collector is connected, the opening must be lined with the edge moulding provided to prevent abrasion of the hose.

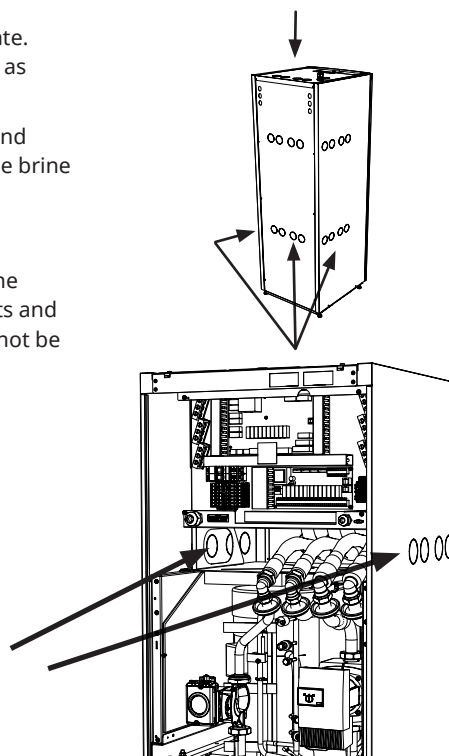

3.3 Heat medium side

Connect the heat pump with a dimension of at least Ø35 mm so it can then be joined to a collecting pipe. The non-return valve and dirt filter are 1¼". The dimension of the collecting pipe depends on the installation.

Route the pipes so that no other highest point is present where air can collect and obstruct circulation. If however this cannot be done, provide this highest point with an automatic bleeder.

NB: Only one heat pump/cooling module can be connected to the diverting valve assembly accessory.

It is very important that the branch pipes are the same design so that as equal a pressure drop as possible is achieved in both the sets of pipes (pipe dimensions, bends, etc.).

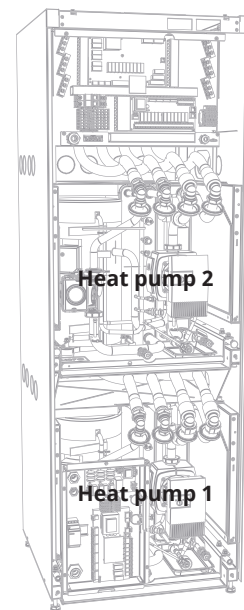
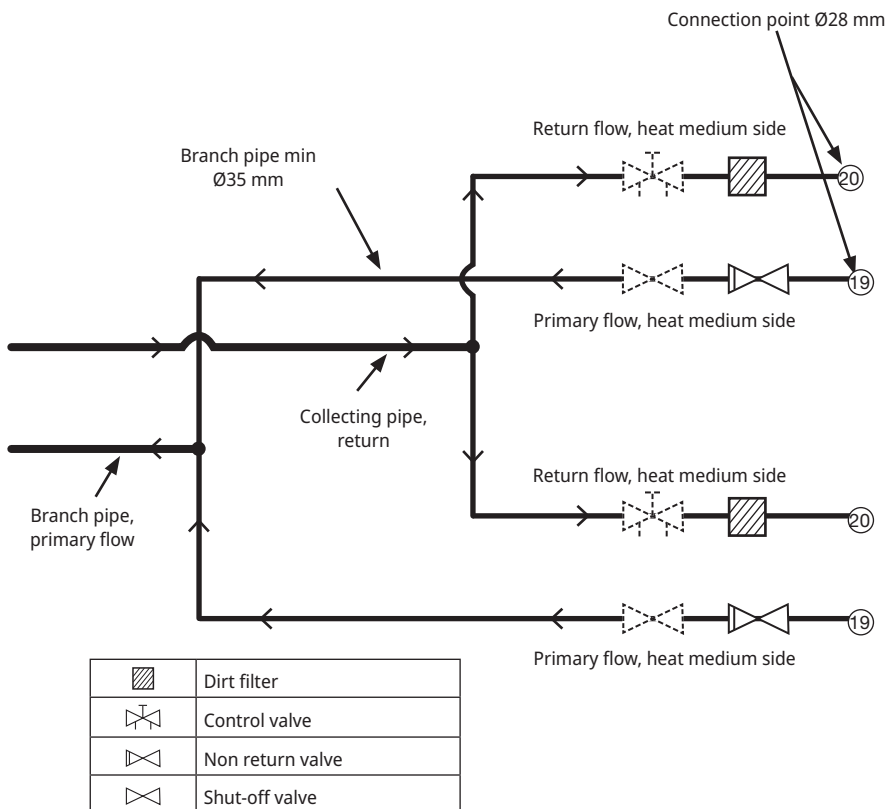

3.4 Circulation pumps, heat medium side

The heat pump is supplied with two LEPs (Low Energy Pump), which are low energy charge pumps installed at the factory.

Circulation pump 8 kW	Yonos Para PWM 7.0	Prod. no. 587477 303
Circulation pump 10-12 kW	Yonos Para PWM 7.5	Prod. no. 587477 302
Circulation pump 14-17 KW	UPMGEO 25-85 130	Prod. no. 587477 301

3.4.1 Yonos Para pump curve

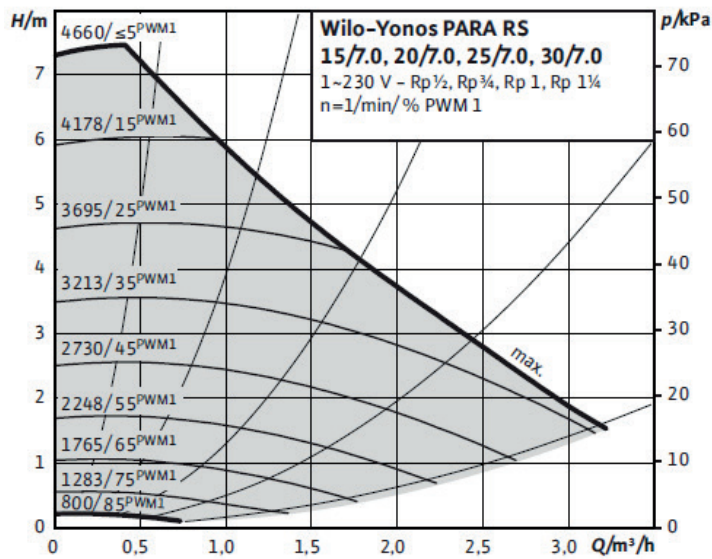

3.4.2 UPMGEO pump curve

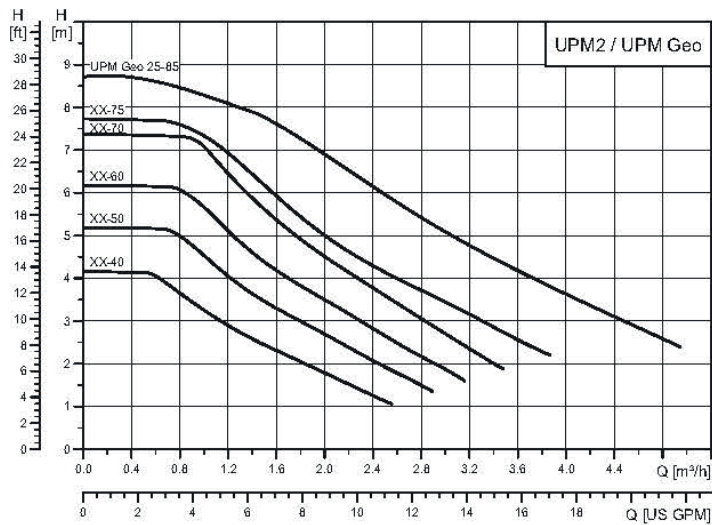

3.5 Brine system

The brine system, i.e. the ground collector loop, must be assembled and connected by a qualified tradesman in accordance with current regulations and design guidelines.

Extreme care must be taken to ensure that no dirt gets on the collector hoses, which must be washed clean before being connected. The protective caps must remain in place at all times while work is in progress.

The temperature of the brine system can fall below 0 °C. It is therefore important that no water-based lubricants and similar are used during installation. It is also important that all the components are insulated against condensation to prevent the build-up of ice.

i We recommend that you follow the installation instructions from the local Heat Pump Association.

! It is very important that the branch pipes are the same design so that as equal a pressure drop as possible is achieved in both the sets of pipes (pipe dimensions, bends, etc.).

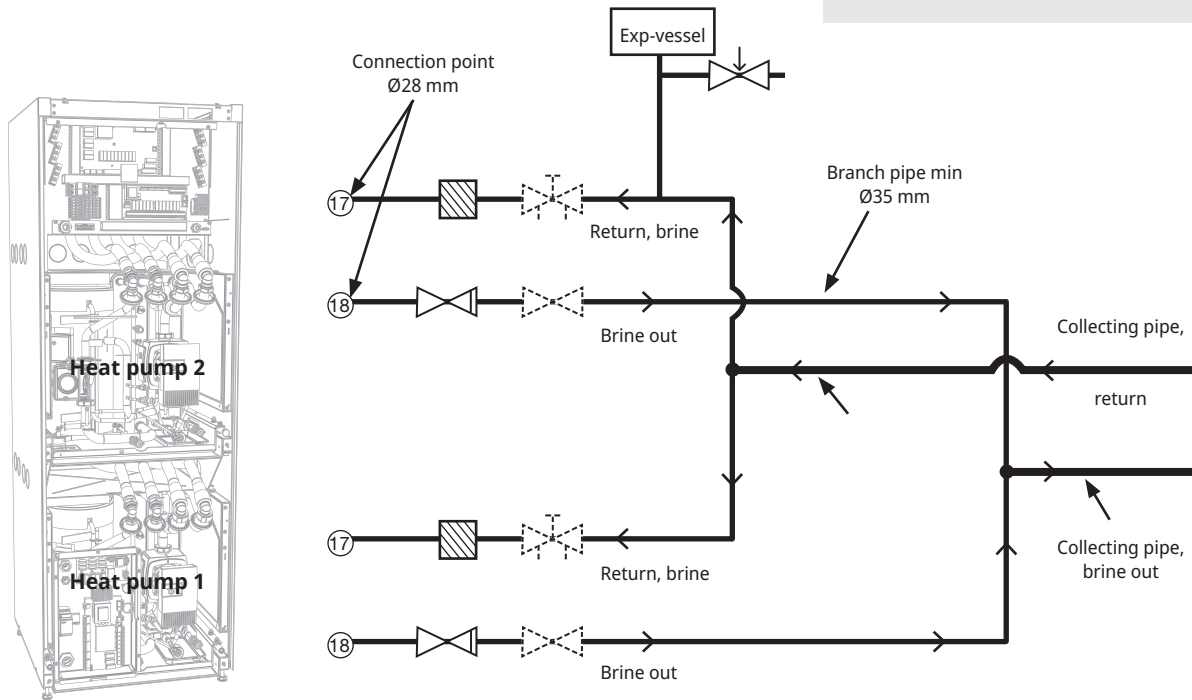

	Dirt filter
	Control valve
	Non return valve
	Shut-off valve

Filling schematic diagram

The filling equipment is represented by the parts displayed with dashes. NB: Collector hoses must have a bleeding facility as air pockets can occur. Always check the filter (99) when filling and bleeding the brine system.

i The mixing vessel and pump must be of a good size.

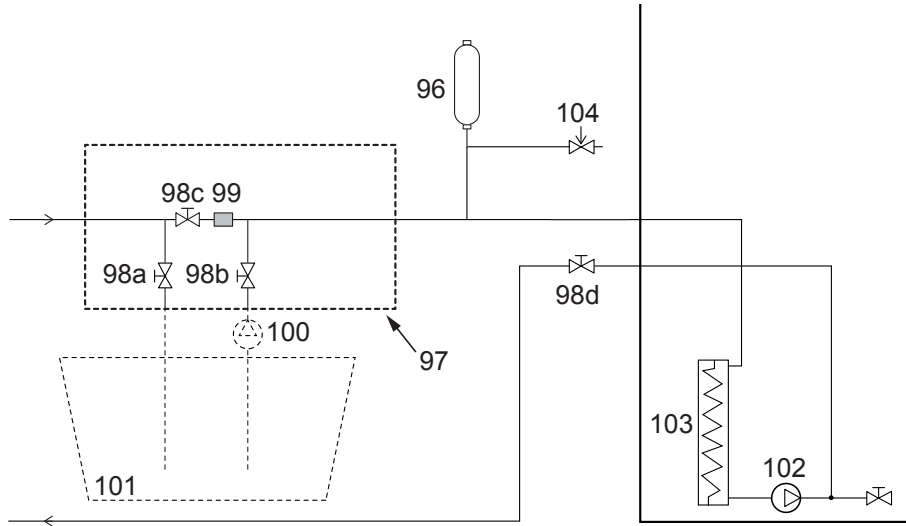

96	Expansion vessel/level vessel	101	Mixing vessel
97	Filling kit	102	Brine pump
98	Shut-off valve	103	Evaporator
99	CTC filter	104	Safety valve 3 bar
100	External filling pump		

Valves

To facilitate servicing of the cooling unit, shut-off valves must be fitted to both the incoming and outgoing connections. Fit bifurcated valves so that you can fill and bleed the collector circuit later on.

Bleeding

The collector circuit must not contain any air. The smallest amount of residual air may compromise the operation of the heat pump, see "Filling and bleeding" below.

Insulation against condensation

All pipes in the brine system must be insulated against condensation to prevent the possibility of severe build-up of ice and condensation.

Filling and venting

Mix water and antifreeze solution in an open vessel. Connect hoses to the shut-off valves (98a and 98b) as shown in the figure. Connect a powerful external pump (101) for refilling and bleeding. Then reset the three-way valve (100) and open the valves (98a and 98b) so that the brine passes through the mixing container (102). Also make sure that the valve (98d) is open.

For start-up of the brine pump, see the relevant manual for the EcoPart's controller.

Allow the brine to circulate in the system for a long period of time until it is completely free of air. There could still be air in the system, even though no air accompanies the liquid out. Reset the 3-way valve (100) so that any remaining air can come out.

Bleed the level vessel (96) by loosening the plug on the top of the level vessel. Now close the valve (98a) while the filling pump continues to run. The filling pump (101) now pressurises the system. Also close the valve (98b) and shut off the filling pump.

If the level in the level vessel is too low, close the valves (98c) and (98d).

Unscrew the plug and fill the vessel to around 2/3 full. Screw the plug back in and open the valves (98c) and (98d).

Post-installation check on brine system

After a few days, you must check the fluid level in the vessel. Fill if necessary and close the valves (98c and 98d) when filling.

Expansion vessel/level vessel

The vessel should be fitted to the incoming line from the borehole or ground loop, at the system's highest point. Bear in mind that the tank can produce condensate on its exterior. Fit the safety valve (105) as shown in the schematic diagram and fit a suitable plug to the top of the vessel.

If the vessel cannot be fitted at the highest point, a closed expansion vessel must be fitted.

Filling kit with dirt filter

Arrows on the valve housing indicate the flow direction. Close valves (98c and 100) when cleaning the filter. Unscrew the filter cap and flush the filter clean. When refitting, the pin under the filter holder should be fed into the designated hole in the filter housing. Top up with a little brine, if necessary, before fitting the cap.

The filter should be checked and cleaned after a short period of operation.

Brine

The brine circulates in a closed system. The fluid consists of water and antifreeze solution. Sentinel R500 & R500C are recommended for use in the brine circuit. The glycol is mixed at a concentration of slightly less than 30%, which is equivalent to fire risk class 2b and a freezing point of around -15°C .

It is a CTC recommendation that around 1 litre of brine/glycol is required per metre of collector hose, i.e. around 0.3 litres of antifreeze solution will be needed per metre of hose, for a hose diameter of 40 mm.

Air pockets

To avoid air pockets, make sure that the collector hoses constantly rise towards the heat pump. If this is not possible, it must be possible to bleed the system at the high points. The filling pump usually manages smaller local height

 Check the dirt filter after bleeding has been completed.

 The fluid must be thoroughly mixed before the heat pump is started.

discrepancies.

Checking brine difference

When the heat pump is running, regularly check that the temperature difference between incoming and outgoing brine temperatures is not too large. If there is a large difference, one of the causes may be due to air in the system or a blocked filter. If this is the case, the heat pump triggers the alarm.

The alarm factory setting is 7°C, but 9°C is permitted for the first 72 hours while the compressor is running, as microbubbles in the system can reduce brine flow.

3.6 Brine pump

Heat pump module	8 kW	10 kW	12 kW	14 kW	17 kW
Brine pump	25-125 180				

The circulation pumps in CTC's products have energy efficiency class A.

25-125-180 PWM, 1x230 V, 50/60 Hz

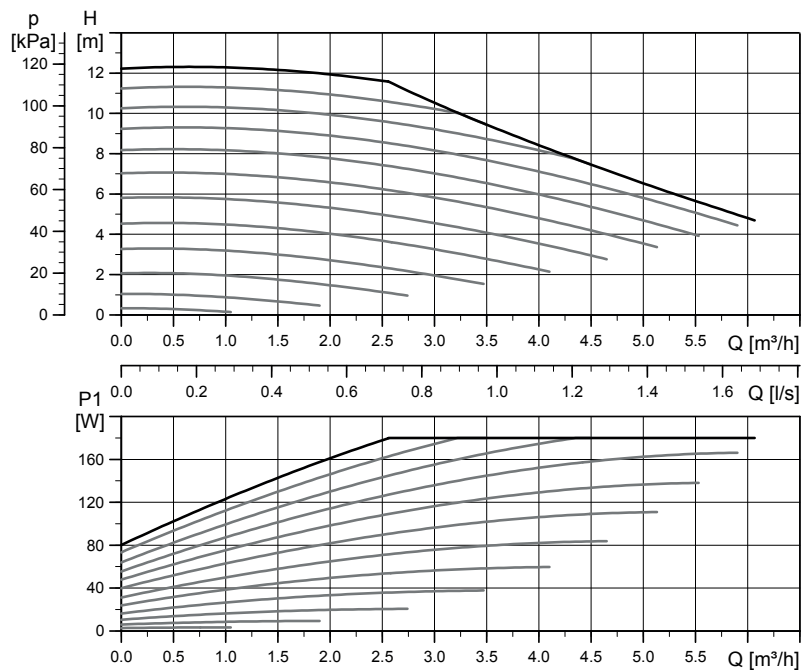

4. Electrical installation

Installation and heat pump connection must be performed by an authorised electrician. All wiring must be installed according to applicable provisions.

- The CTC EcoPart 3 x 400 V must be connected to 400 V 3N~ 50 Hz and protective earth.
- The CTC EcoPart 1 x 230 V must be connected to 230 V 1N~ 50 Hz and protective earth.

The minimum group fuse size is indicated by the “Rated current” under “Technical data”.

Use the cable provided to connect to the power supply. The product is already wired inside.

Omnipolar safety switch

The installation should be preceded by an omnipolar safety switch according to overvoltage category III, which ensures disconnection from all electric power sources.

4.1 Alarm output

The EcoPart is provided with a potential-free alarm output which is activated if any alarm is active in the heat pump. This output may be connected to a maximum load of 1 A 250 V AC. An external fuse should also be used. Cable approved for 230 V AC must be used for connecting this output, irrespective of the load that is connected. For connection information, see the wiring diagram.

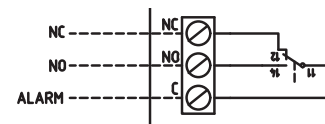

Close-up from wiring diagram.

4.2 Groundwater heating

Groundwater can also be used as a heat source for CTC’s heat pumps. The groundwater is pumped up to an intermediate heat exchanger that transfers the energy to the brine liquid. It is important that an intermediate heat exchanger is installed in the system. The intermediate heat exchanger prevents the product’s evaporator from becoming damaged due to deposits from groundwater particles and minerals, which could otherwise involve expensive work on the product’s refrigerant system. Water requirements analysis should always be undertaken for intermediary heat exchangers. Local regulations and permit requirements must be taken into account. The return water is discharged elsewhere, to a drilled return flow well or similar.

Also pay attention to the intermediary heat exchanger supplier’s instructions.

The brine pump and groundwater pump must be connected to run simultaneously in order to prevent freezing.

5. Connecting the control system

The CTC EcoPart i425-i435 Pro is available in two versions.

- The CTC EcoPart i425-i435 Pro has an integrated CTC EcoLogic L control unit with touchscreen.

The CTC EcoPart 425-435 has two CTC Basic Display units connected to each cooling module. The left-hand display is connected to the lower cooling module (A1) while the right-hand display is connected to the upper cooling module (A2).

All heat pumps are factory-set addressed to A1 – bottom cooling module and A2 – top cooling module. To change the address (e.g. A2 to A3), see the manual for the CTC Basic Display.

5.1 CTC EcoPart i425-i435 Pro

The Pro version is equipped with CTC EcoLogic L. It can control up to 5 products (10 cooling modules).

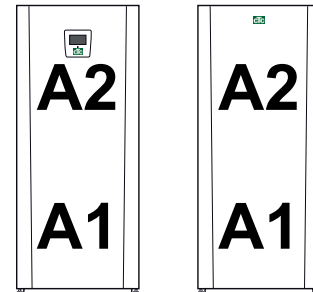

Both the models are factory-set addressed as shown above.

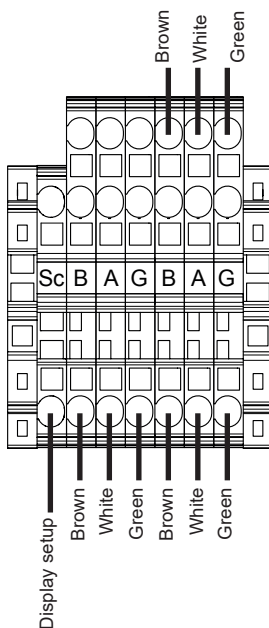

Communication terminal block on the Pro version.

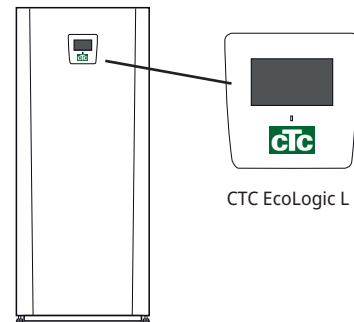

CTC EcoPart i425-i435 Pro

5.2 CTC EcoPart 425-435

The CTC EcoPart 425-435 has two CTC Basic Display units mounted behind the front panel.

The displays are used to address the cooling modules when connecting more than 1 product (2 cooling modules) in series, for example A2 to A4 and A1 to A3, etc. See CTC Basic Display manual for more information.

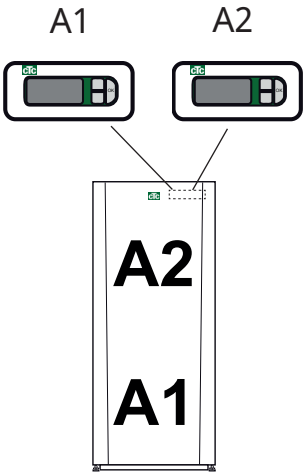
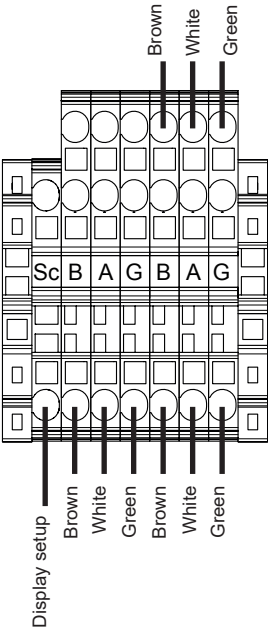

The left-hand display is connected to the bottom cooling module (A1) while the right-hand display is connected to the top cooling module (A2).

5.3 Series connection of heat pumps

When more than one product (two cooling modules) is connected, the subsequent cooling modules must be addressed correctly. The CTC Basic Display on these products can be used to name these products as shown below, see the manual for the CTC Basic Display.

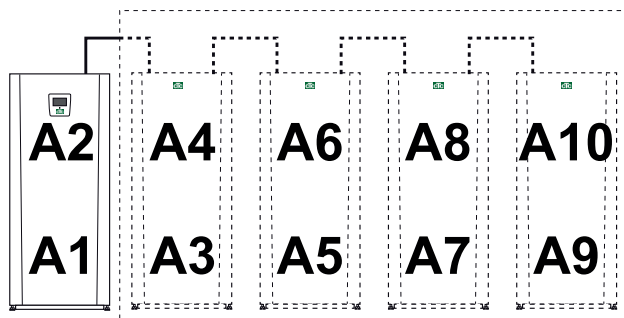

The last heat pump (the cooling module) connected in series must be partly terminated and the shielding in the communication cable must be connected to earth, see below.

5.3.1 Terminated position

The last heat pump connected in series must be terminated. This is achieved with a DIP switch located on the circuit card inside the electrical cabinet.

The top cooling module A2 is terminated at the factory, i.e. DIP switch 2 is in the ON position. In the bottom cooling module A1, DIP switch 2 is in the OFF position. Make sure DIP switch 2 is in the ON position on the module that is to be terminated.

Factory setting of termination

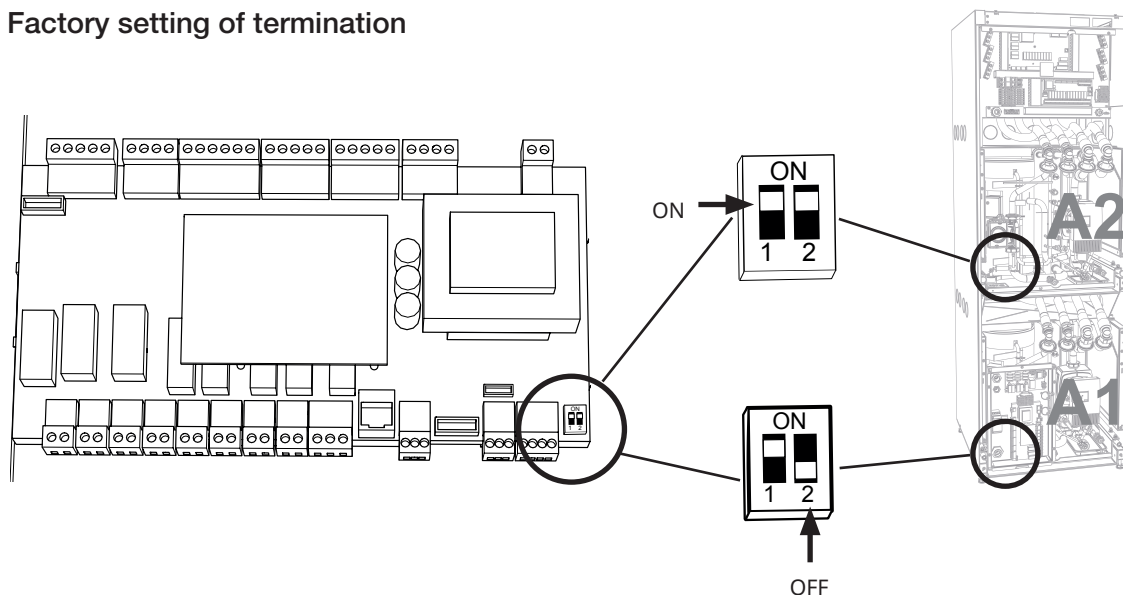

DIP switch 1 is used to set whether a CTC Basic Display is connected. This is why it is set to OFF on the Pro version and ON on the standard version of the heat pump.

5.3.2 Shielded communication

When there is a series connection, the loop which connects position Sc of the control terminal block and PE on the mains terminal block must also be removed and replaced by the shielding, which is then connected up to the next heat pump (control terminal block position Sc). This must be done on all heat pumps except the last cooling module in the series connection.

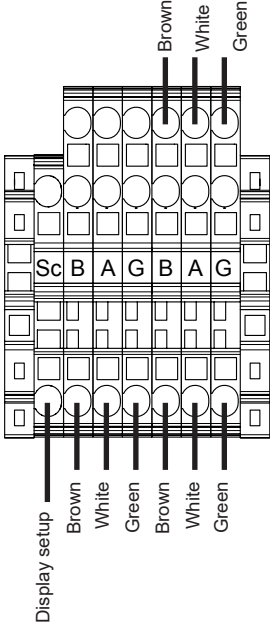

5.3.3 Example of series connection

Heat pumps in series connection

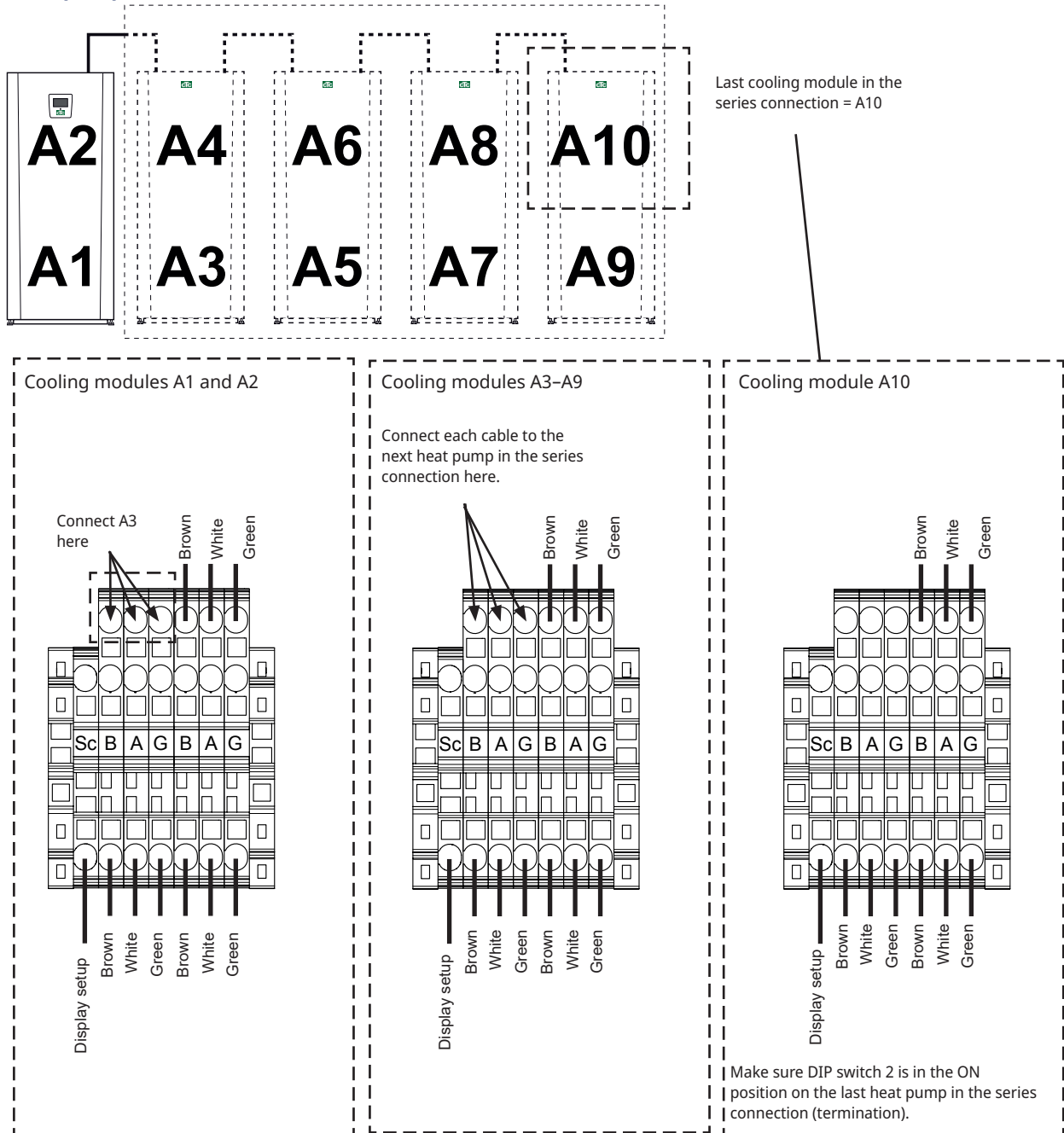

Positions of the DIP switches in the example

Cooling module	A1	A2	A3	A4	A5	A6	A7	A8	A9	A10
Dip-switch 1 Activates the CTC Basic Display	Off	Off	On	On	On	On	On	On	On	On
DIP switch 2 Termination	Off	Off	Off	Off	Off	Off	Off	Off	Off	On

5.4 Connecting the control system

5.4.1 Define number of heat pumps

Define the heat pumps in the controlling product's display under: "Advanced/Define system/Heat pump".

Set the heat pumps contained in the system to position "On".

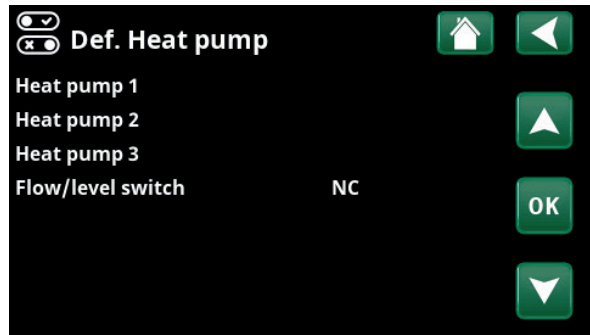

Example of a system with 3 heat pumps.

5.4.2 Numbering CTC EcoPart as HP2

Applies to control launched in October 2020 with three connectors on the back of the display.

2 RJ-45 and 1 RJ-12.

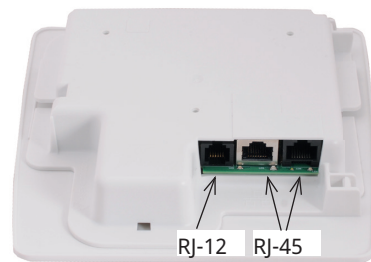

1. System disconnected from power.

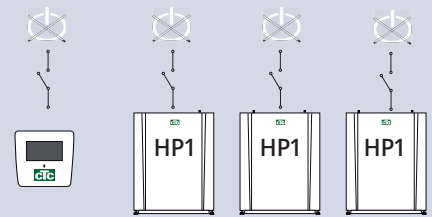

2. Energise the control (EcoLogic or EcoZenith i555 Pro) as well as the CTC EcoPart 600M to be numbered as Heat Pump 2 (HP2).

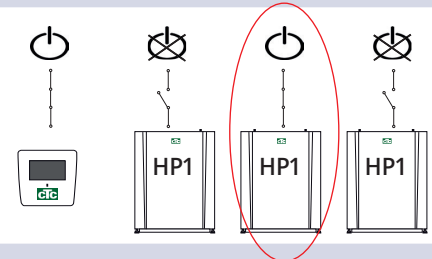

3. Wait for about 2 minutes.

4. Go to "Installer/Service/Set Address".

Select "Current address", press OK and press the down arrow until the current heat pump appears (HP1) Press OK.

Select "New address", press OK and use the arrow to scroll up and down until the address of the current heat pump address is shown (HP2). Press OK.



5. The heat pump is now numbered (HP2).

When you press OK, (HP1 and HP3)* disappears and the row "Current address/New Address" will go dark.

**In this example, we have assumed that the heat pump is called HP1, which is the factory default. If the heat pump has already been renumbered, then select this number instead.*

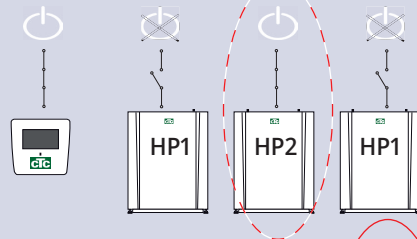
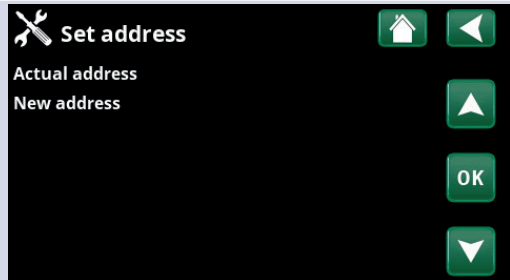

6. Number the other heat pumps:

Energise the next heat pump, which will be numbered heat pump 3 (HP3).

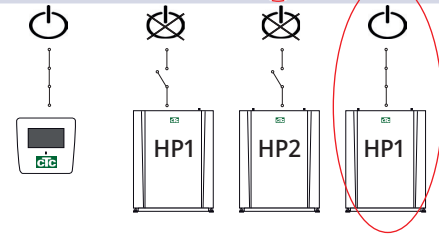

7. Wait 2 minutes.

8. Go to "Service/Set Address".

Select "Current address", press OK and press the down arrow until the current heat pump appears (HP1) Press OK.

Select "New address", press OK and press the up arrow until the current heat pump address appears (HP3). Press OK.

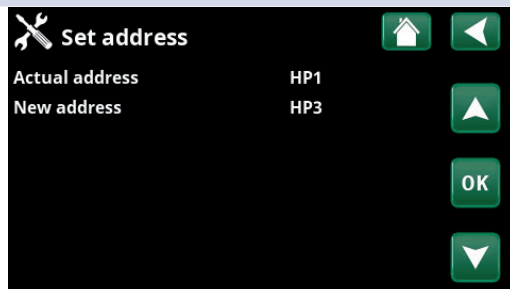

9. The heat pump is now numbered (HP3).

When you press OK, (HP1 and HP3)* disappears and the row "Current address/New address" will go dark.

**In this example, we have assumed that the heat pump is called HP1, which is the factory default. If the heat pump has already been renumbered, then select this number instead.*

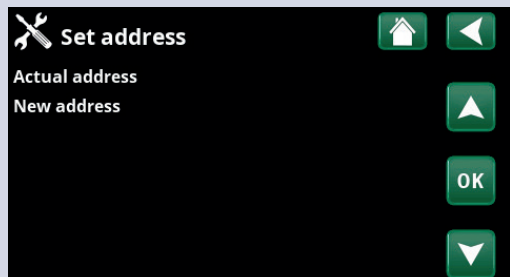

10. Redo the procedure according to the number of heat pumps to be numbered.

When all heat pumps are numbered and energised, they should be displayed when you press the heat pump symbol in the menu "Operation data". If any heat pump does not appear in the menu (communication with the heat pump fails) It may be because it has not been numbered as described above.

If you do not know the name of the heat pump, you can reset the numbering by using the "Select/Rename Heat Pump" menu (refer to points 9 and 10 above) to indicate all possible names of the heat pump, i.e. you select and confirm HP1 and then HP2 up to HP10 to ensure that the correct name is given.

Finally test in the menu "Installer/Service/Function test/Heat pump" that the respective heat pump starts.

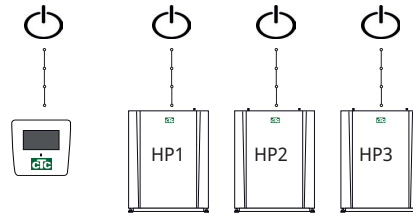

5.4.3 Worth knowing when addressing

Error set Address

- The heat pump could not be found and numbered.
- The heat pump was not what it was supposed to be called.
- No communication with the heat pump.
- Check that the heat pump is energised.

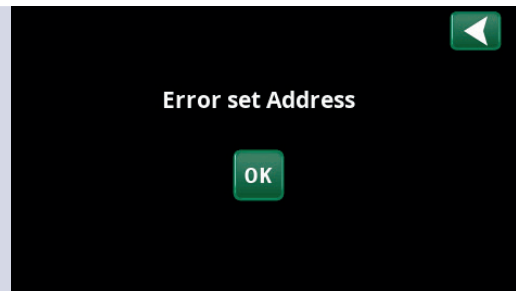

- If the setting of the address fails, the latest heat pump addresses remain. In this example HP1 and HP2.
- Make sure the heat pump is energised.
- Try again with a new current address.

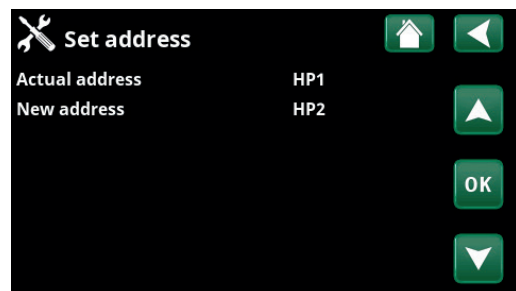

5.4.4 Numbering CTC EcoPart as A2

Applies to older controls with 2 connectors on the back of the display.

1 RJ-45 and 1 RJ-12 for the CTC EcoZenith i550 Pro and CTC EcoLogic Pro/Family.

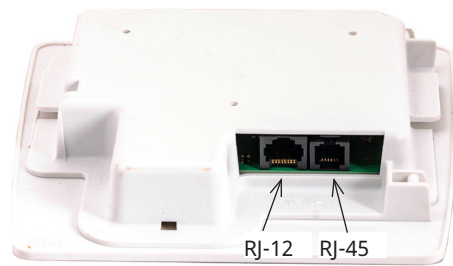

1. System disconnected from power.

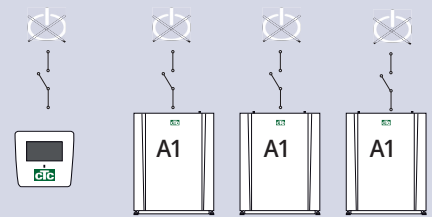

2. Energise the control (EcoLogic Pro or EcoZenith i550 Pro) as well as the CTC EcoPart 600M to be numbered as Heat Pump 2 (A2).

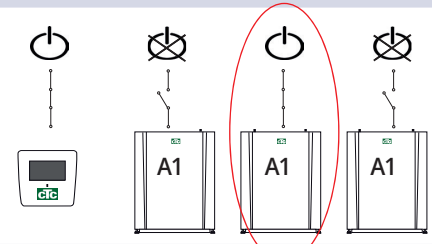

3. Wait approx 2 minutes until the heat pump is visible in the "Operation data" menu.

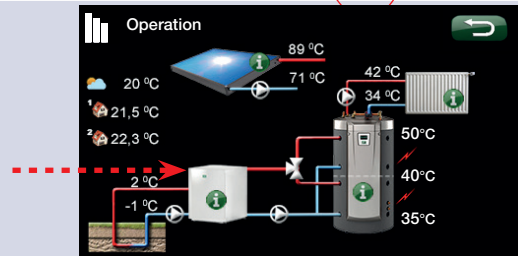

4. Go to Installer/Settings/Heat pump 2 and the row "Select/Rename Heat pump". Press OK.

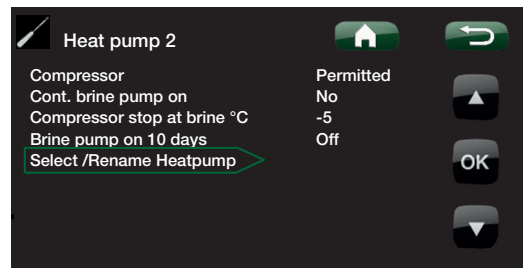

5. Press the arrow up until (A1)* is displayed. Press OK.

After pressing OK, (A1)* disappears and the "Select/Rename Heat Pump" row darkens.

**In this example, we have assumed that the heat pump is called A1, which is the factory default. If the heat pump has already been renumbered, then select this number instead.*

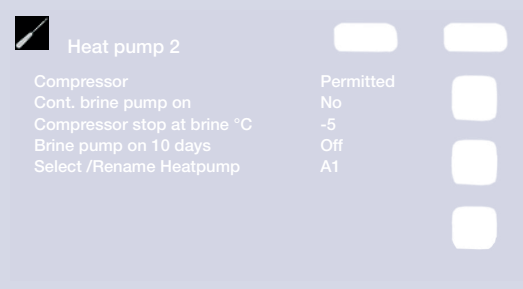

6. The heat pump is now numbered (A2).

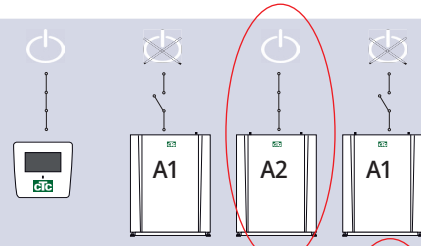

7. To number the other heat pumps:

Energise the control and the next heat pump to be numbered, which will be numbered pump 3 (A3).

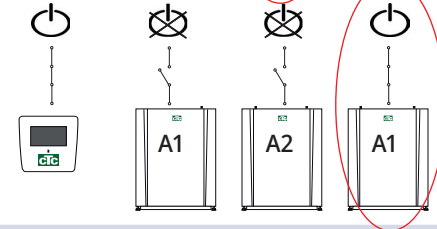

8. Wait approx 2 minutes until the heat pump is visible in the operational information.

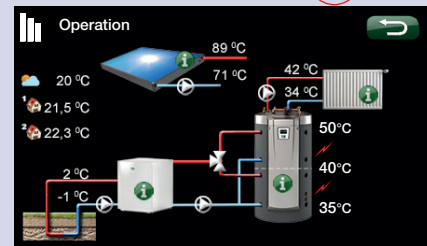

9. Go to Installer/Settings/Heat pump 3 and the row "Select/Rename Heat pump". Press OK.

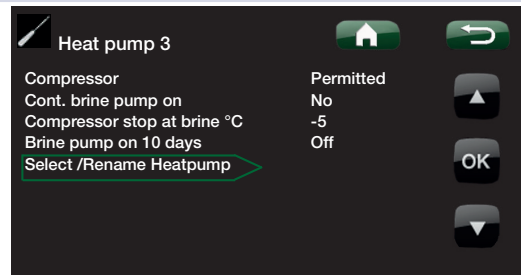

10. Press the arrow up until (A1)* is displayed. Press OK.

After pressing OK, (A1)* disappears and the "Select/Rename Heat Pump" row darkens. The heat pump is now numbered (A3).

**In this example, we have assumed that the heat pump is called A1, which is the factory default. If the heat pump has already been renumbered, then select this number instead.*

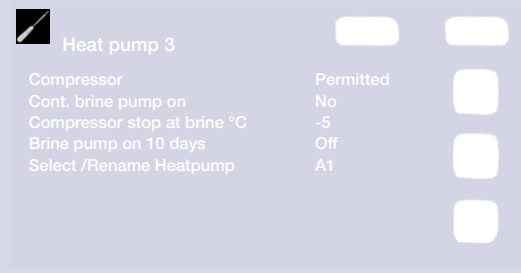

11. Redo the procedure according to the number of heat pumps to be numbered.

When all heat pumps are numbered and energised, they should be displayed when you press the heat pump symbol in the menu "Operation data". If any heat pump does not appear in the menu (communication with the heat pump fails) It may be because it has not been numbered as described above.

If you do not know the name of the heat pump, you can reset the numbering by using the "Select/Rename Heat Pump" menu (refer to points 9 and 10 above) to indicate all possible names of the heat pump, i.e. you select and confirm A1 and then A2 up to A10 to ensure that the correct name is given.

Finally test in the menu "Advanced/Service/Function test/Heat pump" that the respective heat pump starts.

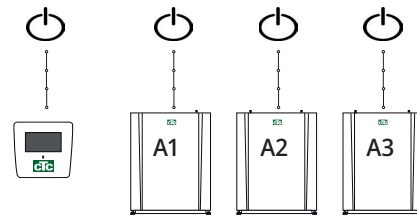

5.5 Wiring diagram for CTC i425-i435 Pro 400V 3N~

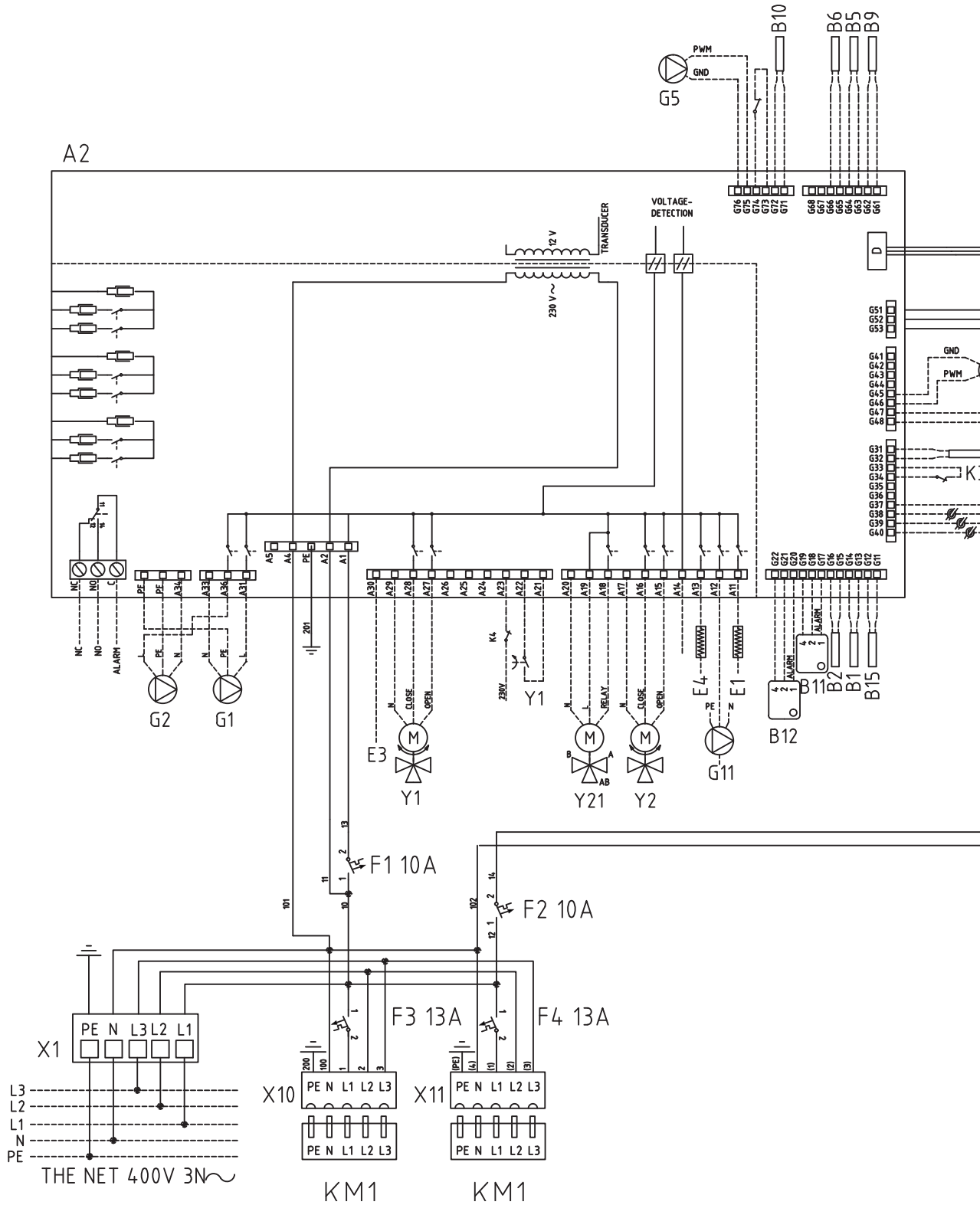

5.6 Electrical diagram, lower cooling module 400V 3N~ L2

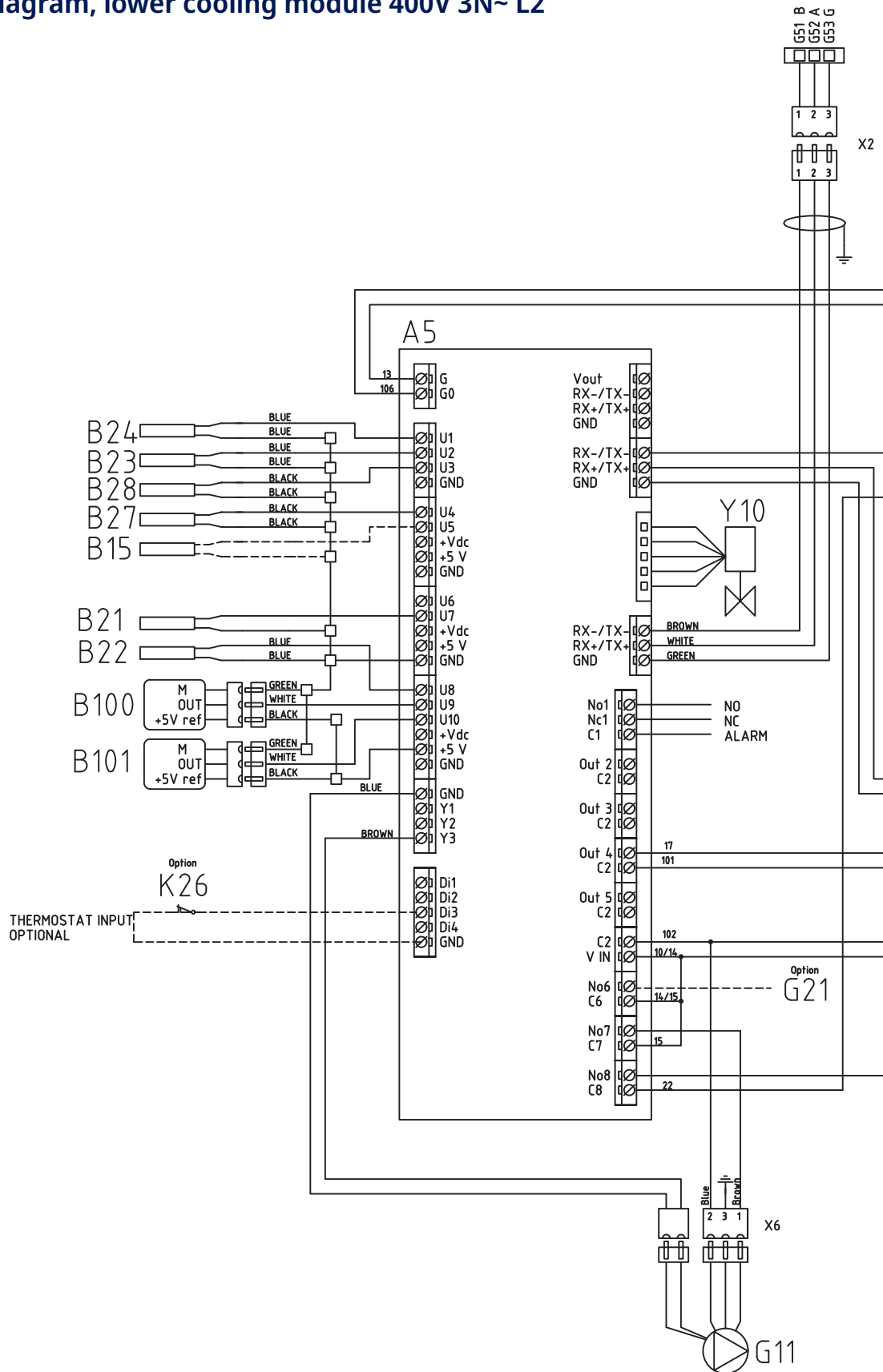

On products with S/N up to 7301-2135-0494, pump G20 is connected to L1.

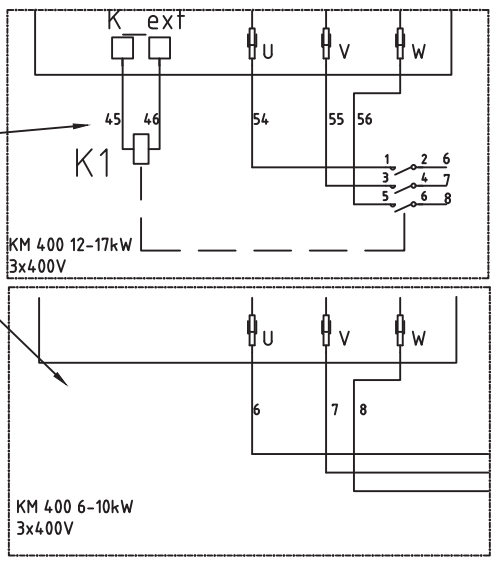
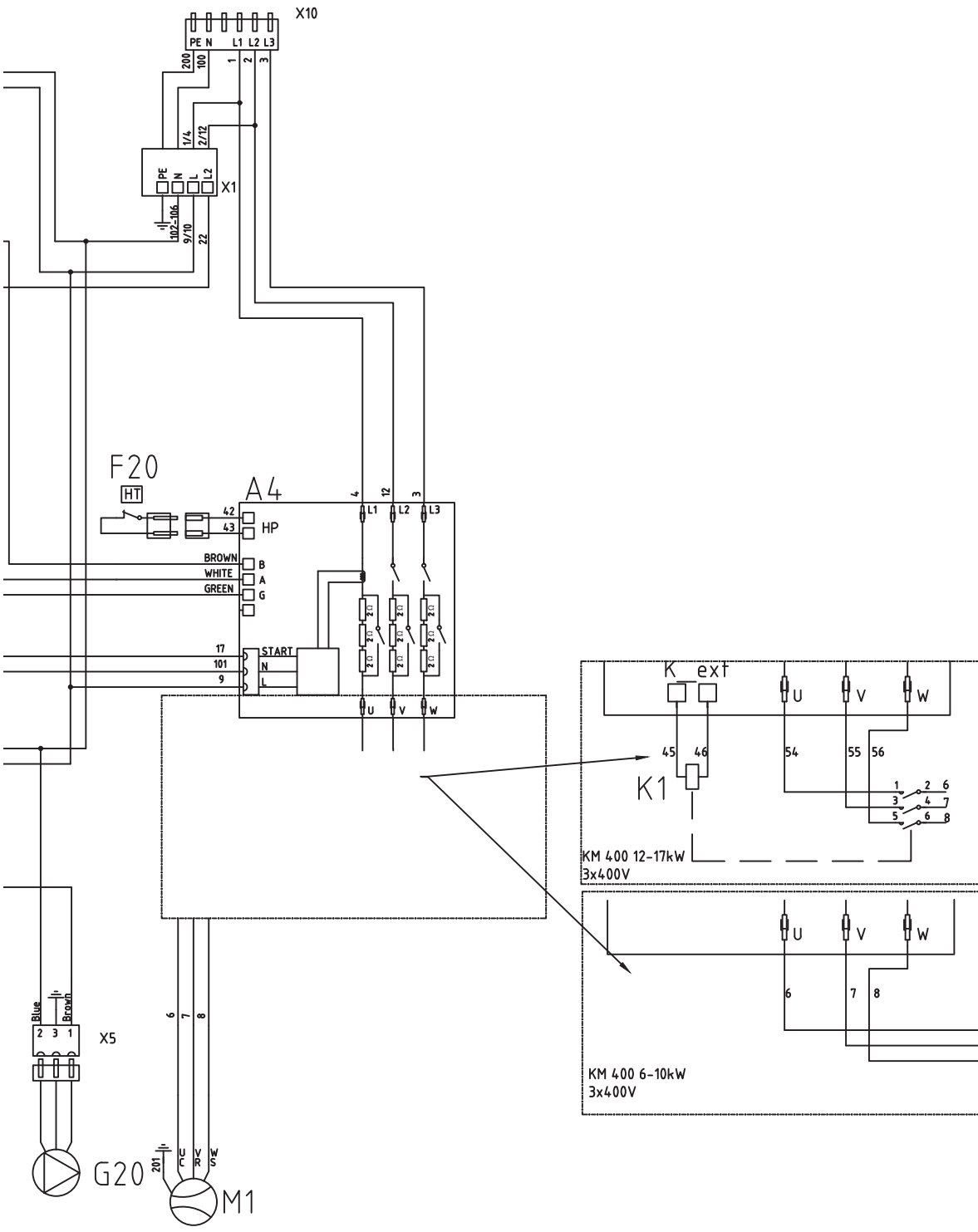

5.7 Electrical diagram, upper cooling module 400V 3N~ L3

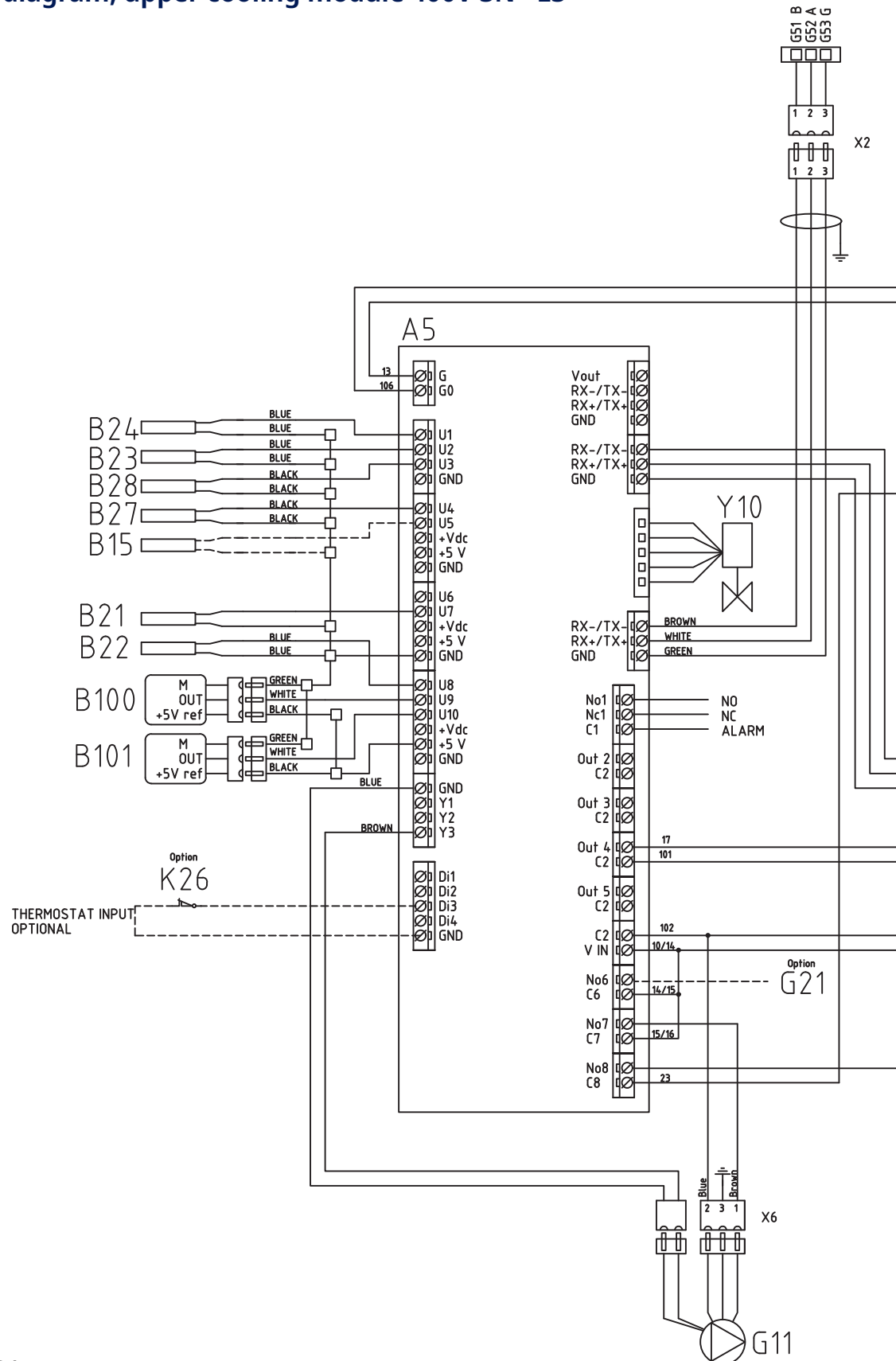

On products with S/N up to 7301-2135-0494,
pump G20 is connected to L1.

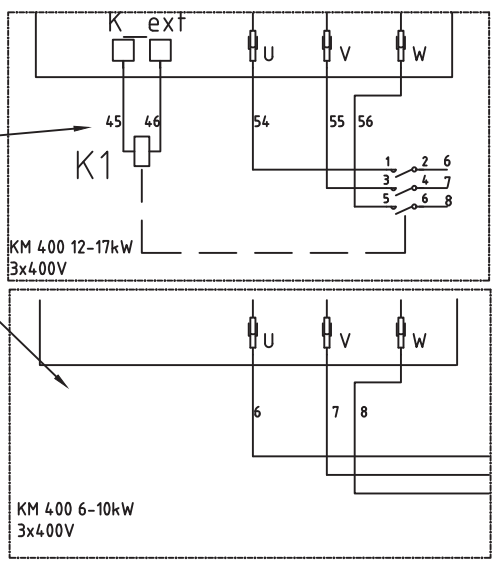
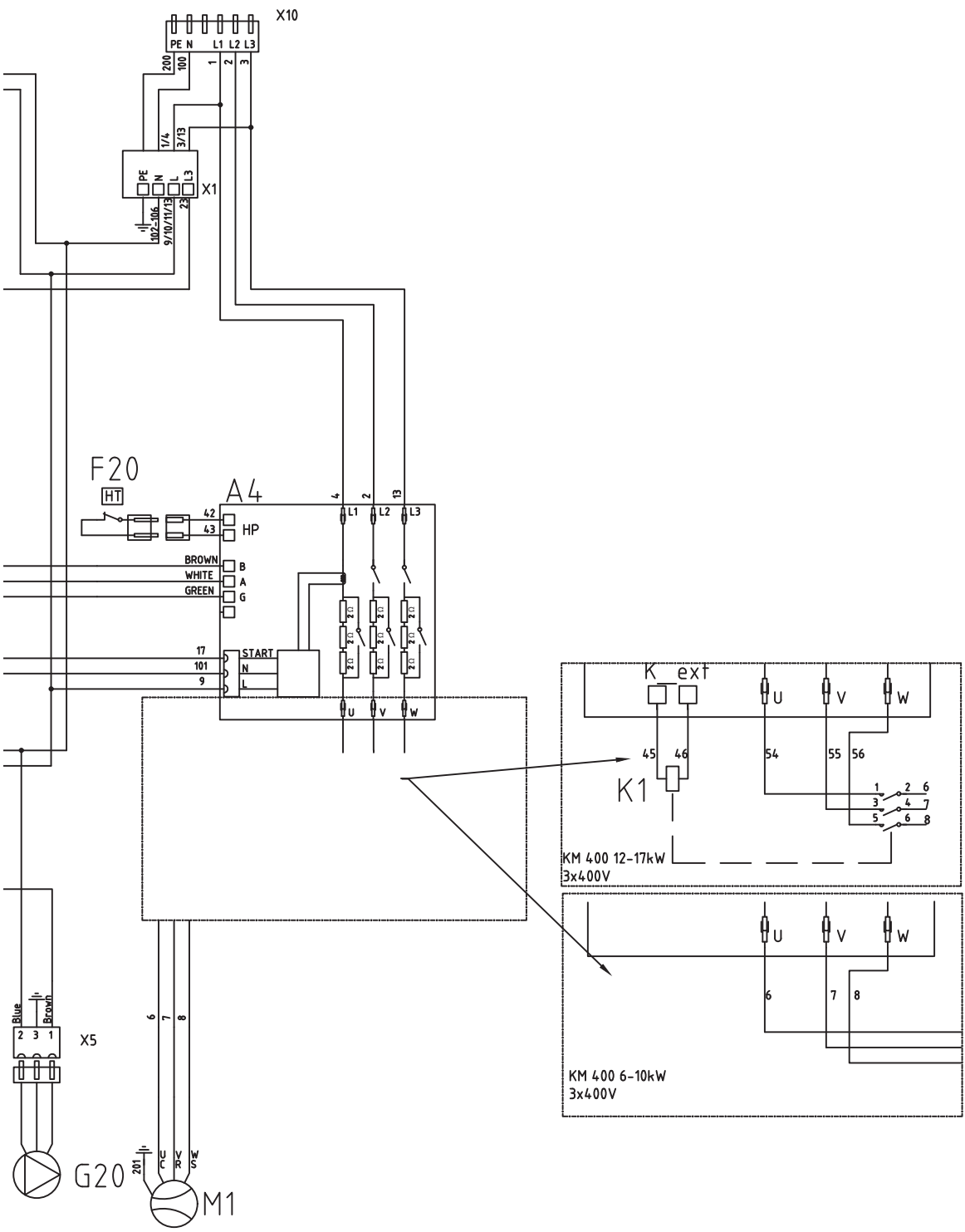

5.8 Electrical diagram CTC EcoPart i425-i430 Pro 230V 1N~

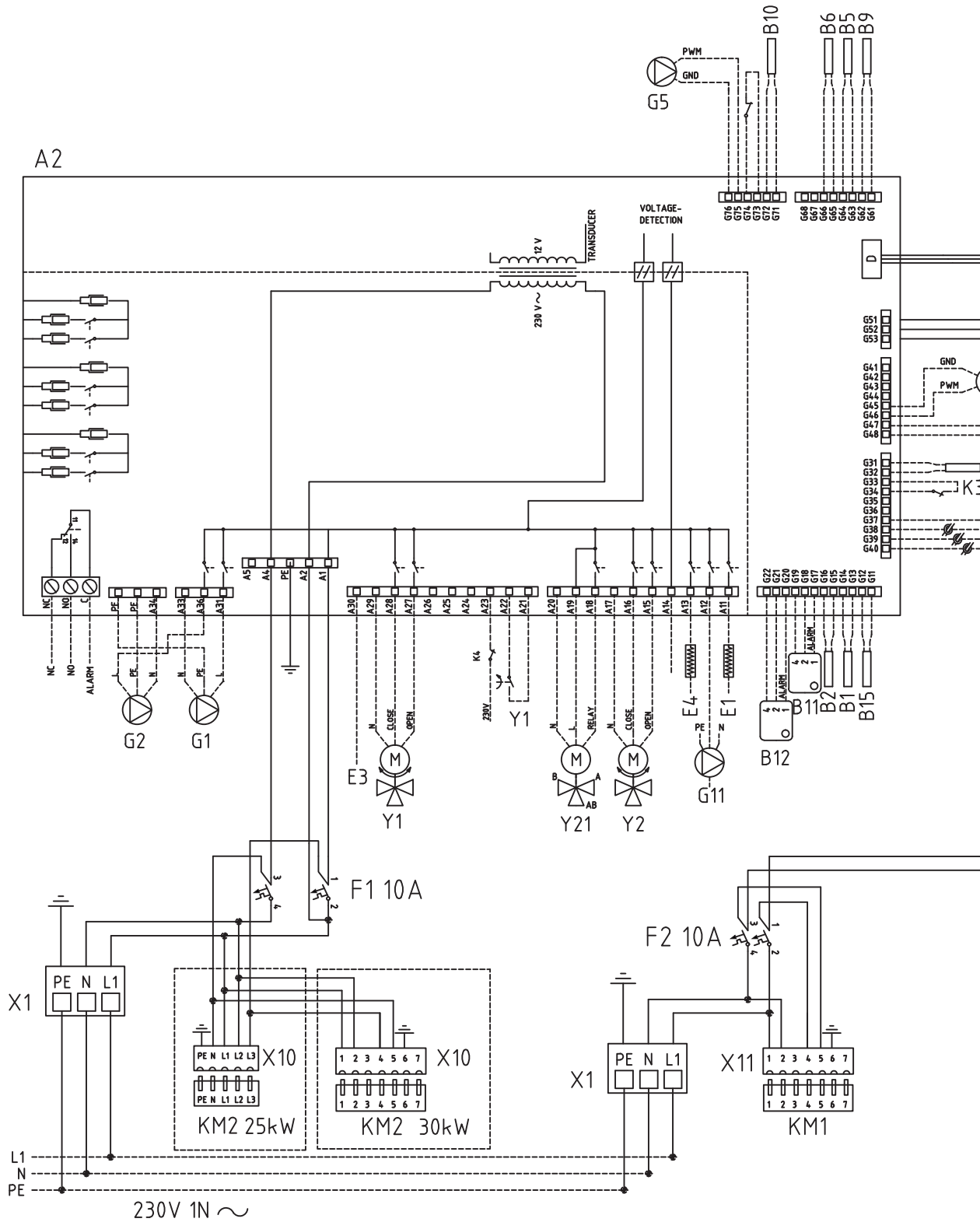

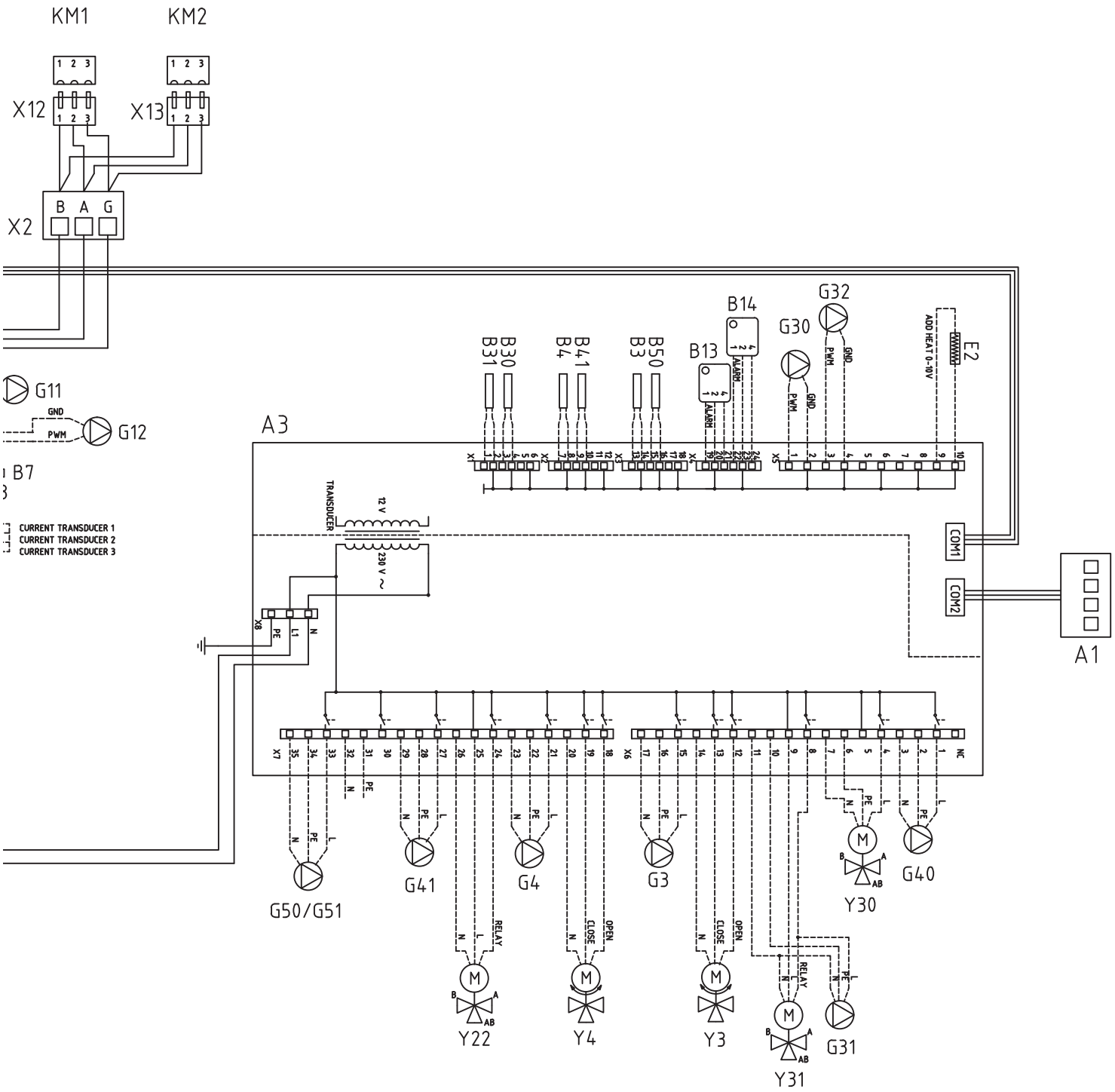

5.9 Power supply and communication 230V 1N~

CTC EcoPart 425-430

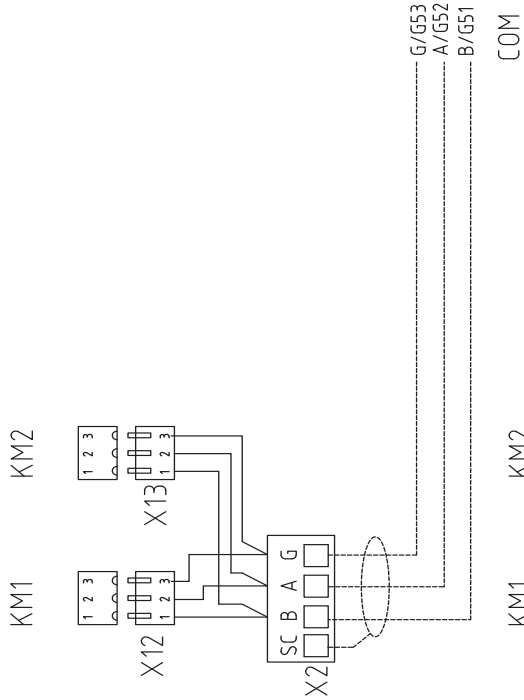

-301
25kW

①

LOOK AT ELECTRICAL DIAGRAM
COOLING MODULE

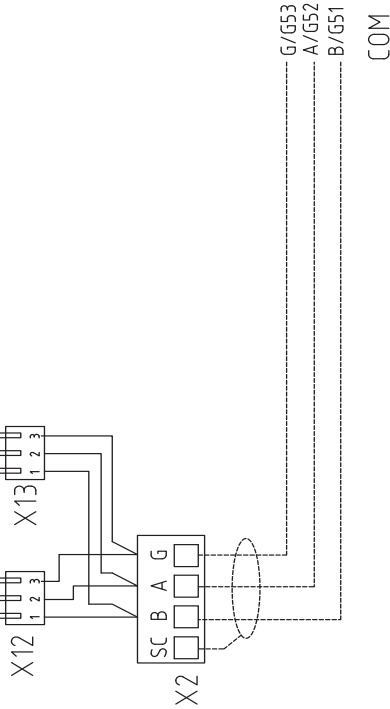

-302
30kW

①

LOOK AT ELECTRICAL DIAGRAM
COOLING MODULE

① WITH NET 3x230V~
USE PHASE L2 (N)

5.10 Power supply and communication 400V 3N~

CTC EcoPart 425-435

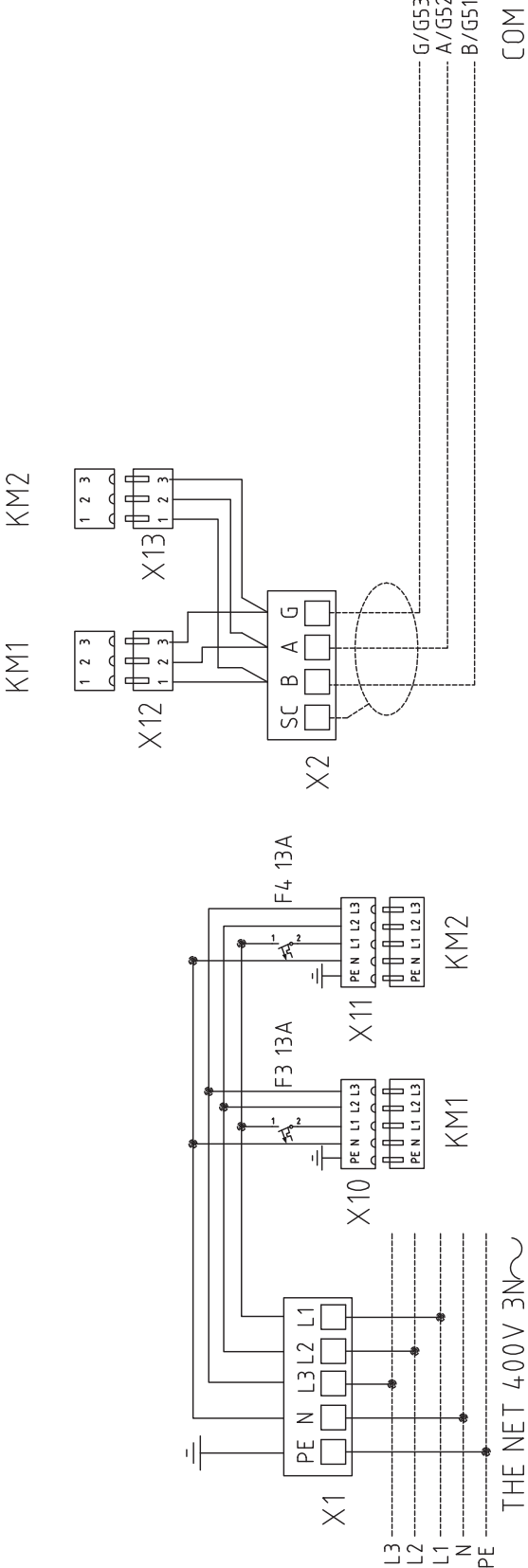

5.11 Electrical diagram cooling module 230V 1N~

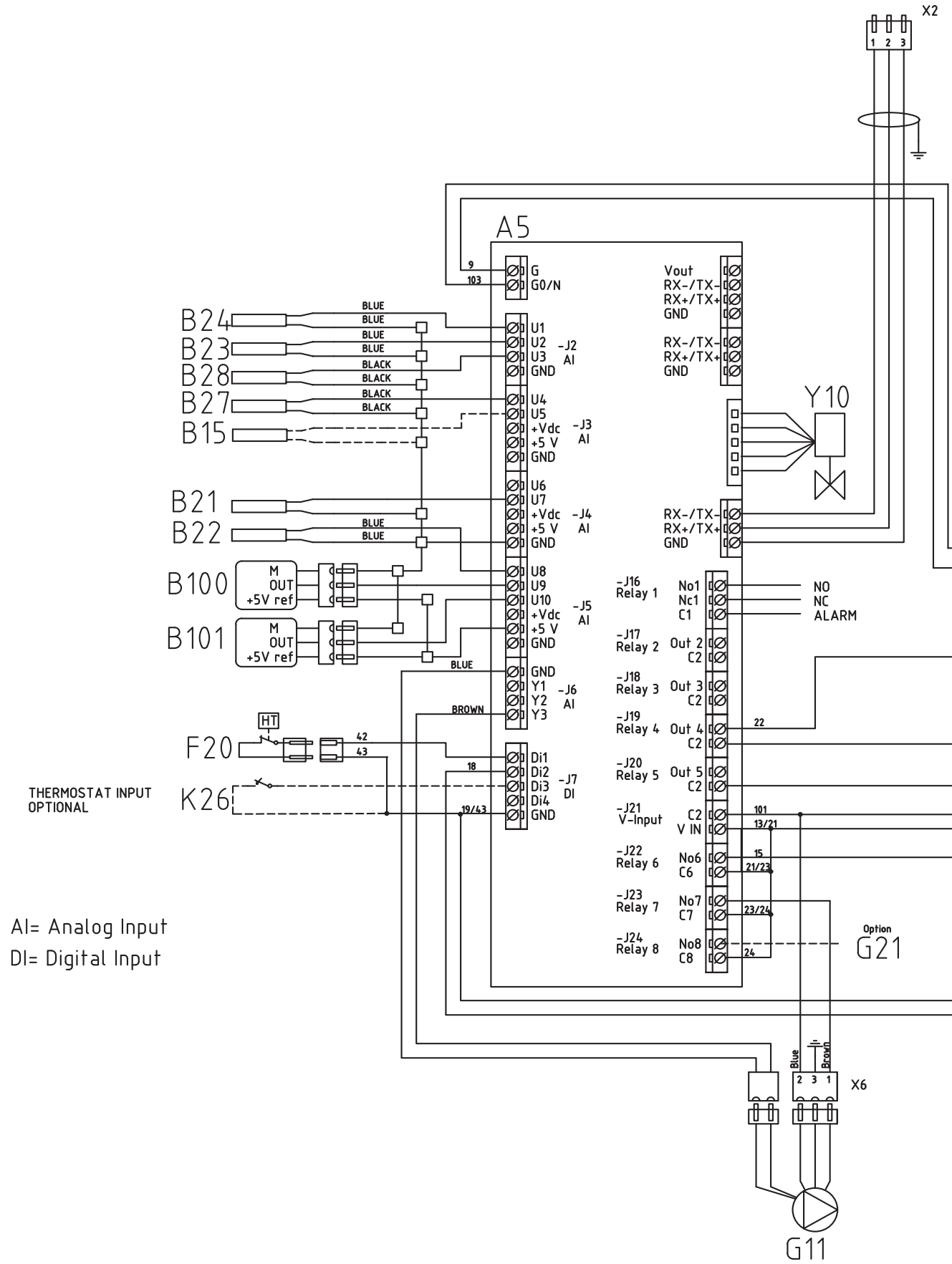

WITH NET 3x230V
 PHASE L2 = (N)

LOOK AT ELECTRICAL DIAGRAM CONTROL UNIT

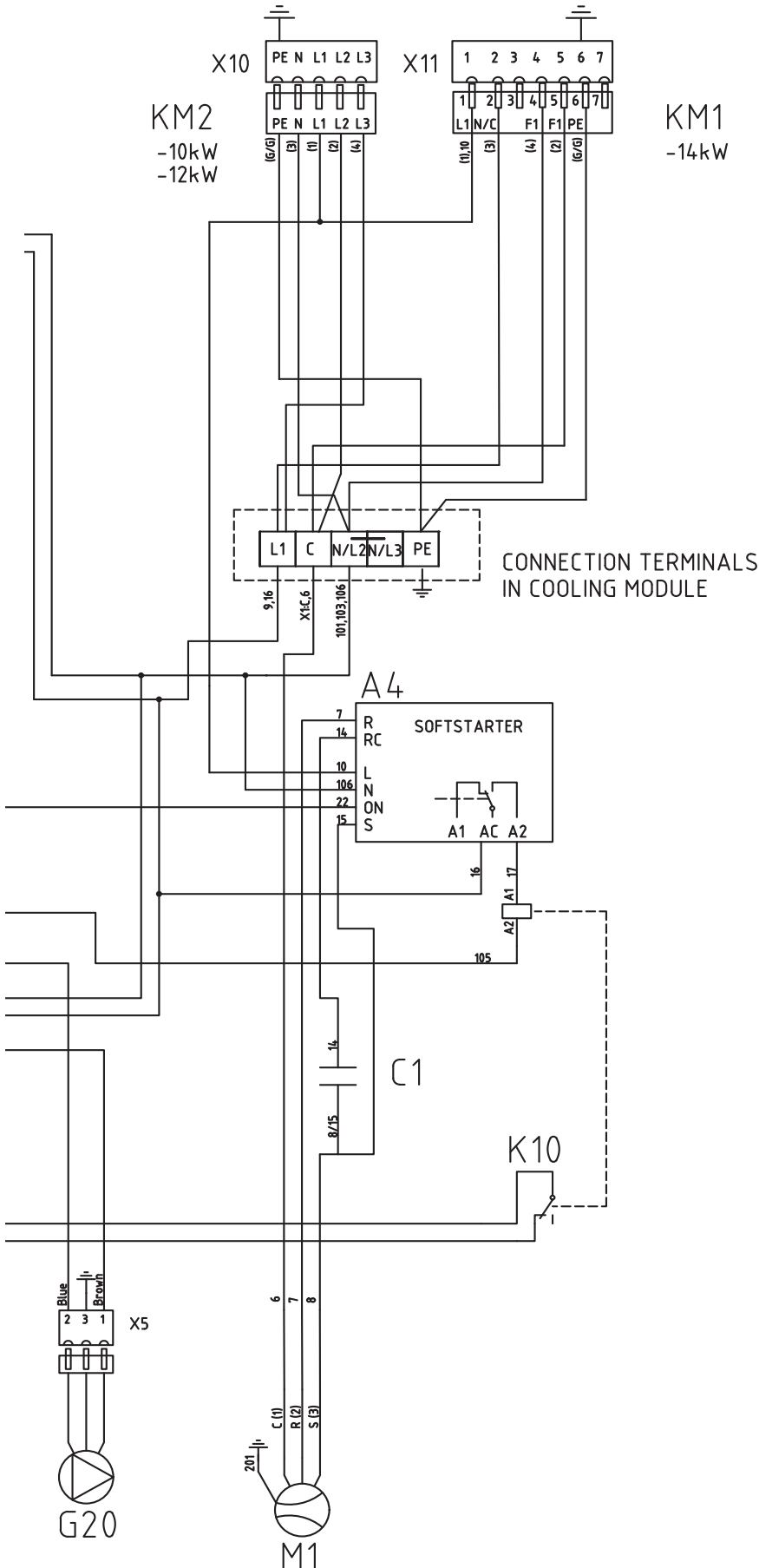

5.12 Connection table (all heat pump models)

This table shows connections on the relay board A2 (or expansion board A3), see wiring diagram.

E1	Additional heat		A2 X1 X1	A11 N PE	Relay Output
E2	Additional heat, 0-3 step/0-7 step	x	A2 A2 A2 A2 A2 A2 X1 X1	EL1A EL2A EL1A+EL2A EL3A EL1A+EL3A EL1A+EL2A+EL3A N PE	
E2	Additional heat, 0-10V analog	x	A3 A3	X5: 9 X5: 10	
E3	Additional heat, EcoMiniEI 0-3 step		A2 X1 X1	A30 N PE	Comm 230V
E4	Additional heat, DHW		A2 X1 X1	A13 N PE	Relay Output
G1	Circulation pump 1		A2 A2 A2	A31 PE A33	Phase PE GND
G2	Circulation pump 2		A2 A2 A2	A36 PE A34	Phase PE GND
G3*	Circulation pump 3	x	A3 A3 A3	X6: 15 X6: 16 X6: 17	Phase PE GND
G4*	Circulation pump 4	x	A3 A3 A3	X7: 21 X7: 22 X7: 23	Phase PE GND
G5	Circulation pump, DHW exchange		A2 A2	G75 G76	PWM+ GND
G11	Charge pump HP1		A2 A2 A2	G45 G46 A12	GND PWM+ Relay Output
G12	Charge pump HP2		A2 A2	G47 G48	GND PWM+
G13*	Charge pump HP3	x	A3 A3	X5: 5 X5: 6	PWM+ GND
G14*	Charge pump HP4	x	A3 A3	X5: 7 X5: 8	PWM+ GND
G30*	Circulation pump, solar panels	x	A3 A3	X5: 1 X5: 2	PWM+ GND
G31*	Charge pump, recharge bedrock	x	A3 A3 A3	X6: 8 X6: 10 X6: 11	Phase PE GND
G32*	Pump, heat exchanger solar panels	x	A3 A3	X5: 3 X5: 4	PWM+ GND
G40*	Circulation pump, DHW circ.	X	A3 A3 A3	X6: 1 X6: 2 X6: 3	Phase PE GND

*Applies if the accessory CTC Expansion has been installed.

G41*	Circulation pump external DHW tank	X	A3 A3 A3	X7: 27 X7: 28 X7: 29	Phase PE GND
G50/G51*	Circulation pump, pool	X	A3 A3 A3	X7: 33 X7: 34 X7: 35	Phase PE GND
K22	Remote control, SmartGrid		A2	A14	**
K22/K23	Remote control, SmartGrid		A2	A25	**
K23	Remote control, SmartGrid		A2	A24	**
K24	Remote control, SmartGrid		A2	G33	**
K24	Remote control, SmartGrid		A2	G34	**
K25	Remote control, SmartGrid		A2	G73	**
K25	Remote control, SmartGrid		A2	G74	**
Y1	Mixing valve 1		A2 A2 A2	A27 A28 A29	Open Close GND
Y2	Mixing valve 2		A2 A2 A2	A15 A16 A17	Open Close GND
Y3*	Mixing valve 3	X	A3 A3 A3	X6: 12 X6: 13 X6: 14	Open Close GND
Y4*	Mixing valve 4	X	A3 A3 A3	X7: 18 X7: 19 X7: 20	Open Close GND
Y21	3-way valve HP1		A2 A2 A2	A18 A19 A20	Relay Output Phase GND
Y22	3-way valve HP2		A3 A3 A3	X7: 24 X7: 25 X7: 26	Relay Output Phase GND
Y30*	Sol, 3-way valve DHW	X	A3 A3 A3 A3	X6: 4 X6: 5 X6: 7 X6: 6	Voltage, control Phase GND PE
Y31*	3-way valve, solar	X	A3 A3 A3	X6: 8 X6: 9 X6: 11	Open ground source Open tank GND
Y50		X	A3 A3 A3	X7: 33 X7: 34 X7: 35	Relay Output PE GND
Y61*	3-way valve, active cooling	X	A3 A3 A3	X7: 30 X7: 32 X7: 25	Relay Output GND Phase
Y62*	3-way valve, active cooling	X	A3 A3 A3	X6: 8 X6: 11 X6: 9	Relay Output GND Phase
B1	Primary flow sensor 1		A2 A2	G13 G14	
B2	Primary flow sensor 2		A2 A2	G15 G16	
B3*	Primary flow sensor 3	X	A3 A3	X3: 13 X3: 14	
B4*	Primary flow sensor 4	X	A3 A3	X2: 7 X2: 8	

*Applies if the accessory CTC Expansion has been installed.

**Connection as described in Remote control manual

G5	Sensor, DHW tank		A2 A2	G63 G64	
B6	Sensor, Buffer tank		A2 A2	G65 G66	
B7	Sensor return, heating circuit		A2 A2	G31 G32	
B8	Sensor, flue gas		A2 A2	G35 G36	
B9	Sensor, External Boiler		A2 A2	G61 G62	
B10	Sensor, External Boiler out		A2 A2	G71 G72	
B11	Room sensor 1		A2 A2 A2	G17 G18 G19	
B12	Room sensor 2		A2 A2 A2	G20 G21 G22	
B13*	Room sensor 3	X	A3 A3 A3	X5:19 X5:20 X5:21	1 4 2
B14*	Room sensor 4	X	A3 A3 A3	X5:22 X5:23 X5:24	1 4 2
B15	Outdoor sensor		A2 A2	G11 G12	
B30*	Sensor, solar panels in	X	A3 A3	X1:3 X1:4	
B31*	Sensor, solar panels out	X	A3 A3	X1:1 X1:2	
B43*	Sensor, external DHW tank	X	A3 A3	X2:9 X2:10	
B50*	Sensor, pool	X	A3 A3	X3:15 X3:16	
B61	Sensor, cooling tank active cooling	X	A3 A3	X3:17 X3:18	
B73	Sensor, return active cooling	X	A3 A3	X3:11 X3:12	
B103	Current sensors		A2 A2 A2 A2	G37 G38 G39 G40	Common L1 L2 L3
HP1	Heat pump 1				
HP2	Heat pump 2				
HP3	Heat pump 3	X			
HP4	Heat pump 4	X			
HP5	Heat pump 5	X			
HP6	Heat pump 6	X			
HP7	Heat pump 7	X			
HP8	Heat pump 8	X			
HP9	Heat pump 9	X			
HP10	Heat pump 10	X			

*Applies if the accessory CTC Expansion has been installed.

5.13 Connection table, cooling module

This table shows connections on the HP A5 control board (in the cooling module), see electrical diagram.

A4	Soft-start card with motor protection and contactor function		A5 A5 A5	RT-/TX- RT+/TX+ GND	B A G
B21	Temperature sensor Discharge		A5 A5	J4: U7 GND	
B22	Temperature sensor Suction gas		A5 A5	J5: U8 GND	
B23	Sensor, Brine in		A5 A5	J2: U2 GND	
B24	Sensor, Brine out		A5 A5	J2: U1 GND	
B27	Sensor, HP in		A5 A5	J3: U4 GND	
B28	Sensor, HP out		A5 A5	J2: U3 GND	
B100	High pressure sensor			J4: GND J5: U9 J5: +5V	M OUT +5V ref
B101	Low pressure sensor		A5	J4: GND J5: U10 J5: +5V	M OUT +5V ref
F20	High pressure switch		A4 A4	HP HP	
G11	Charge pump HP1		A5 A5 A5 A5 A5	J23: No7 GND J21: C2 G0 X1: N J6: GND J6: Y3	X6: 1 X6: 3 X6: 2 X6: 2 X6: 2
G20	Brine pump		A5 A5 A5	J24: No8 GND J21: C2 G0 X1: N	X5: 1 X5: 3 X5: 2 X5: 2 X5: 2
G21	Option		A5	J22: NO6	
K26	Option		A5	J7: DI J7: GND	
M1	Compressor			U (KM400) V (KM400) W (KM400)	

5.14 Resistances for sensors

Sensor Type 1 NTC Resistance kΩ		Sensor Type 2 NTC Resistance kΩ		Sensor Type 3 NTC Resistance kΩ		NTC 50 Resistance kΩ	
Temperature °C	Resistance kΩ	Temperature °C	Resistance kΩ	Temperature °C	Resistance kΩ	Temperature °C	Resistance kΩ
100	0.22	100	0.67	130	5.37	150	0.89
95	0.25	95	0.78	125	6.18	145	1.00
90	0.28	90	0.908	120	7.13	140	1.14
85	0.32	85	1.06	115	8.26	135	1.29
80	0.37	80	1.25	110	9.59	130	1.47
75	0.42	75	1.47	105	11.17	125	1.67
70	0.49	70	1.74	100	13.06	120	1.91
65	0.57	65	2.07	95	15.33	115	2.19
60	0.7	60	2.5	90	18.1	110	2.5
55	0.8	55	3.0	85	21.4	105	2.9
50	0.9	50	3.6	80	25.4	100	3.4
45	1.1	45	4.4	75	30.3	95	3.9
40	1.3	40	5.3	70	36.3	90	4.6
35	1.5	35	6.5	65	43.6	85	5.4
30	1.8	30	8.1	60	52.8	80	6.3
25	2.2	25	10	55	64.1	75	7.4
20	2.6	20	12.5	50	78.3	70	8.8
15	3.2	15	15.8	45	96.1	65	10.4
10	4	10	20	40	119	60	12.5
5	5	5	26	35	147	55	15
0	6	0	33	30	184	50	18
-5	7	-5	43	25	232	45	22
-10	9	-10	56	20	293	40	27
-15	12	-15	74	15	373	35	33
-20	15	-20	99	10	479	30	40
-25	19	-25	134	5	619	25	50
-30	25	-30	183			20	62
						15	78
						10	99
						5	126

Temperature °C	NTC 22 kΩ Resistance Ω
130	800
125	906
120	1027
115	1167
110	1330
105	1522
100	1746
95	2010
90	2320
85	2690
80	3130
75	3650
70	4280
65	5045
60	5960
55	7080
50	8450
45	10130
40	12200
35	14770
30	18000
25	22000
20	27100
15	33540
10	41800
5	52400
0	66200
-5	84750
-10	108000
-15	139000
-20	181000
-25	238000

Temperature °C	NTC 150 Resistance Ω
70	32
65	37
60	43
55	51
50	60
45	72
40	85
35	102
30	123
25	150
20	182
15	224
10	276
5	342
0	428
-5	538
-10	681
-15	868
-20	1115
-25	1443
-30	1883
-35	2478
-40	3289

Temperature °C	NTC 015 Resistance Ω
40	5830
35	6940
30	8310
25	10000
20	12090
15	14690
10	17960
5	22050
0	27280
-5	33900
-10	42470
-15	53410
-20	67770
-25	86430

5.15 Parts list

A1	Display	
A2	Relay/main card	
A3	Expansion card	
A4	Soft-start card with motor protection and contactor function	
A5	HP control card	
B1	Primary flow sensor 1	NTC 22
B2	Primary flow sensor 2	NTC 22
B3	Primary flow sensor 3	NTC 22
B4	Primary flow sensor 4	NTC 22
B7	Return sensor	NTC 22
B8	Sensor flue gas	NTC 3.3
B9	Sensor external boiler	NTC 22
B10	Sensor external boiler out	NTC 22
B11	Room sensor 1	NTC 22
B12	Room sensor 2	NTC 22
B11	Room sensor 3	NTC 22
B12	Room sensor 4	NTC 22
B15	Outdoor sensor	NTC 150
B21	Temperature sensor Discharge	Type 3/ NTC 50
B22	Temperature sensor Suction gas	Type 1/ NTC 015
B23	Brine in	Type 1/ NTC 22
B24	Brine out	Type 1/ NTC 22
B27	HP in	Type 2/ NTC 22
B28	HP out	Type 2/ NTC 22
B43	Sensor external DHW tank	NTC 22
B50	Sensor pool	NTC 22
B100	High pressure sensor	
B101	Low pressure sensor	
C1	Operating condenser	
F1	Automatic circuit breaker	10 A
F2	Automatic circuit breaker	13 A
F20	High pressure switch	
G1	Circulation pump 1	
G2	Circulation pump 2	
G11	Charge pump HP1	
G20	Brine pump	
G40	Circulation pump for DHW circ.	
G41	Circulation pump external DHW tank	
G50	Circulation pump, pool	
G51	Circulation pump, pool	
K1	Contactor 1	
K10	Relay	
K26	Thermostatic control, accessory (Basic Display)	
L1	Induction coil	
M1	Compressor	
X1	Terminal board	
X10	Extra terminal board	
Y1	Mixing valve 1	
Y2	Mixing valve 2	
Y10	Expansion valve	
Y21	3-way valve DHW 1	
Y22	3-way valve DHW 2	
Y41	External heat source tank	
Y50	3-way valve, pool	

6. First start

1. Check that the heating boiler and system are full of water and have been bled.
2. Check that all connections are tight.
3. Check that sensors and the radiator pump are connected to the power source.
4. Energise the heat pump by switching on the safety switch (the main switch).

Once the system has heated up, check that all connections are tight, the various systems have been bled, heat is coming out into the system and DHW is coming out at the tap locations.

7. Operation and Maintenance

When the installer has installed your new heat pump, you should check along with the installer that the system is in perfect operating condition. Let the installer show you where the power switches, controls and fuses are so that you know how the system works and how it should be maintained. Bleed the radiators (depending on type of system) after around three days of operation and top up with water if required.

7.1 Periodic maintenance

After three weeks of operation and every three months of the first year, thereafter once a year:

- Check that the installation is free of leaks.
- Check that the product and system are free of air; bleed if needed – see the section Connecting the brine system.
- Check that the brine system is still pressurised and that the fluid level in the brine vessel is adequate/correct.
- The products do not require annual inspection for refrigerant leakage.

7.2 Operation stop

The heat pump is shut down using the operating switch. If there is a risk of the water freezing, drain out all the water.

7.3 Service position

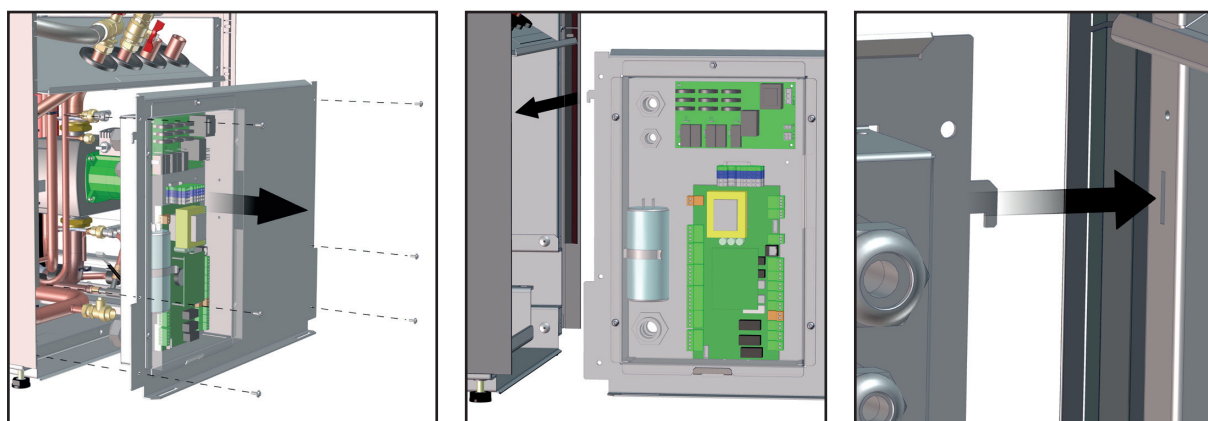

8. Troubleshooting/Appropriate measures

The heat pump is designed to provide reliable operation and high levels of comfort, and to have a long service life.

Various tips are given below which may be helpful and guide you in the event of an operational malfunction.

If a fault occurs, you should always contact the installer who installed your unit.

If the installer believes the malfunction is due to a materials or design fault, then they will contact Eneritech AB to check and rectify the issue. Always enter the product's serial number.

8.1 Air problems

If you hear a rasping sound from the heat pump, check that it is properly bled.

Top up with water where required, so that the correct pressure is achieved. If this noise recurs, call a technician to check the cause.

